

Smart Sensors: Inductive Displacement Type ZX-E Series

Operation Manual

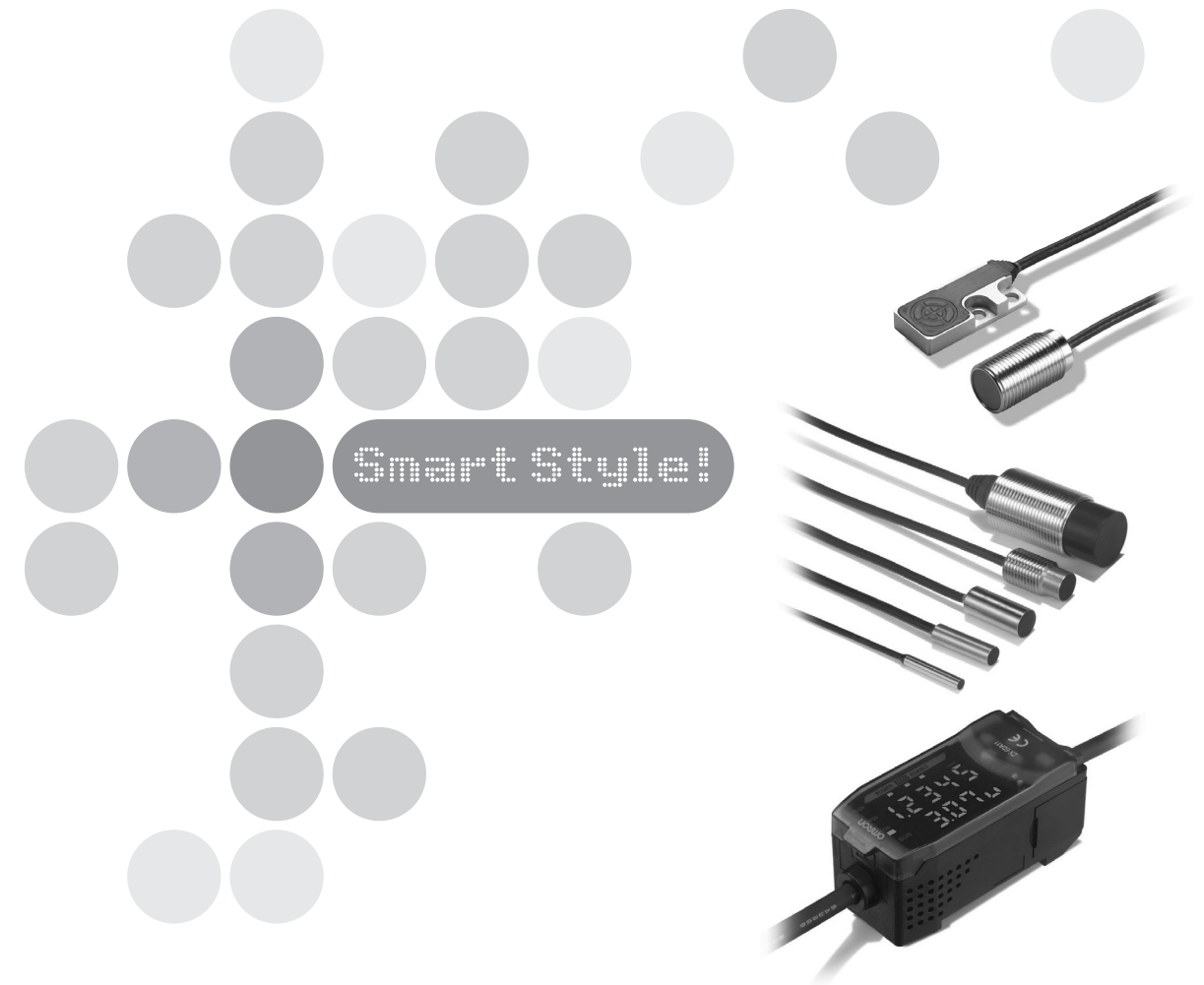

Cat. No. Z166-E1-02A

ZX-E Series Smart Sensors: Inductive Displacement Type

Operation Manual

OMRON

OMRON Corporation
Industrial Automation Company

Sensing Devices Division H.Q.
Application Sensors Division
Shiokoji Horikawa, Shimogyo-ku,
Kyoto, 600-8530 Japan
Tel: (81)75-344-7068/Fax: (81)75-344-7107

Regional Headquarters
OMRON EUROPE B.V.
Sensor Business Unit,
Carl-Benz-Str. 4, D-71154 Nufringen,
Germany
Tel: (49)7032-811-0/Fax: (49)7032-811-199

OMRON ELECTRONICS LLC
1 East Commerce Drive, Schaumburg, IL 60173
U.S.A.
Tel: (1)847-843-7900/Fax: (1)847-843-8568

OMRON ASIA PACIFIC PTE. LTD.
83 Clemenceau Avenue,
#11-01, UE Square,
239920 Singapore
Tel: (65)6835-3011/Fax: (65)6835-2711

OMRON (CHINA) CO., LTD.
Room 2211, Bank of China Tower,
200 Yin Cheng Road (M)
Shanghai, 200120 China
Tel: (86)21-5037-2222/Fax: (86)21-5037-2200

Authorized Distributor:

Introduction

Thank you for purchasing an OMRON ZX-E-series Smart Sensor (Inductive Displacement Type). We hope you will fully utilize this product and its performance for many years to come.

This manual describes the functions, performance, and application methods of a ZX-E Smart Sensor. To ensure safety, read this manual carefully before using the Sensor. In addition, keep this manual in an easily accessible location for quick reference when needed.

Preface	Contents, Warranty and Application Considerations, Precautions for Safe Use/Correct Use, and How to Use this Manual	Preface
Section 1	Features	Section 1
Section 2	Preparations for Measurement	Section 2
Section 3	Basic Operation	Section 3
Section 4	Main Applications and Setting Methods	Section 4
Section 5	Detailed Settings	Section 5
Section 6	Auxiliary Functions	Section 6
Appendices	Troubleshooting, Specifications, Characteristic Data, etc.	Appendices
Index		Index

Operation Manual

**Smart Sensors
ZX-E Series**

Contents

Contents	3
Warranty and Application Considerations	7
Precautions for Safe Use	11
Precautions for Correct Use	12
How to Use This Manual	13
<hr/>	
Section 1 Features	15
ZX-E Features	16
<hr/>	
Section 2 Preparations for Measurement	23
Basic Configuration	24
Part Names and Functions	25
Installing the Amplifier Unit	28
Installing Sensor Heads	30
Connections	34
Wiring Output Cables	38
Confirming Warm-up Completion	41

Section 3 Basic Operation	43
Flow of Operation	44
Basic Knowledge for Operation	46
Function Transition Charts	51
Adjusting Linearity	54
Section 4 Main Applications and Setting Methods	61
Detecting Bottom Deadpoint	62
Measuring Height	67
Measuring Eccentricity and Vibration	71
Measuring Thickness	74
Section 5 Detailed Settings	79
Setting Number of Samples to Average	80
Using Hold Functions	81
Comparing Measured Values (Previous Value Comparisons)	88
Changing Display Scales	90
Entering Threshold Values	97
Linear Output	103
Setting Judgement Output Timing (Timer)	112

Section 6 Auxiliary Functions	115
Measuring with Multiple Amplifier Units	116
Changing the Number of Display Digits	123
Reversing the Display	124
Adjusting Display Brightness (ECO Display)	126
Using the Zero Reset Function	127
Key Lock Function	132
Initializing Settings Data	133
Appendices	135
Troubleshooting	136
Error Messages and Countermeasures	137
Q&A	138
Glossary	139
Specifications and Dimensions	140
Characteristic Data	148
Quick Reference for Displays	157
Index	161
Revision History	165

READ AND UNDERSTAND THIS DOCUMENT

Please read and understand this document before using the products. Please consult your OMRON representative if you have any questions or comments.

WARRANTY

OMRON's exclusive warranty is that the products are free from defects in materials and workmanship for a period of one year (or other period if specified) from date of sale by OMRON.

OMRON MAKES NO WARRANTY OR REPRESENTATION, EXPRESS OR IMPLIED, REGARDING NON-INFRINGEMENT, MERCHANTABILITY, OR FITNESS FOR PARTICULAR PURPOSE OF THE PRODUCTS. ANY BUYER OR USER ACKNOWLEDGES THAT THE BUYER OR USER ALONE HAS DETERMINED THAT THE PRODUCTS WILL SUITABLY MEET THE REQUIREMENTS OF THEIR INTENDED USE. OMRON DISCLAIMS ALL OTHER WARRANTIES, EXPRESS OR IMPLIED.

LIMITATIONS OF LIABILITY

OMRON SHALL NOT BE RESPONSIBLE FOR SPECIAL, INDIRECT, OR CONSEQUENTIAL DAMAGES, LOSS OF PROFITS OR COMMERCIAL LOSS IN ANY WAY CONNECTED WITH THE PRODUCTS, WHETHER SUCH CLAIM IS BASED ON CONTRACT, WARRANTY, NEGLIGENCE, OR STRICT LIABILITY.

In no event shall responsibility of OMRON for any act exceed the individual price of the product on which liability is asserted.

IN NO EVENT SHALL OMRON BE RESPONSIBLE FOR WARRANTY, REPAIR, OR OTHER CLAIMS REGARDING THE PRODUCTS UNLESS OMRON'S ANALYSIS CONFIRMS THAT THE PRODUCTS WERE PROPERLY HANDLED, STORED, INSTALLED, AND MAINTAINED AND NOT SUBJECT TO CONTAMINATION, ABUSE, MISUSE, OR INAPPROPRIATE MODIFICATION OR REPAIR.

SUITABILITY FOR USE

THE PRODUCTS CONTAINED IN THIS DOCUMENT ARE NOT SAFETY RATED. THEY ARE NOT DESIGNED OR RATED FOR ENSURING SAFETY OF PERSONS, AND SHOULD NOT BE RELIED UPON AS A SAFETY COMPONENT OR PROTECTIVE DEVICE FOR SUCH PURPOSES. Please refer to separate catalogs for OMRON's safety rated products.

OMRON shall not be responsible for conformity with any standards, codes, or regulations that apply to the combination of products in the customer's application or use of the product.

At the customer's request, OMRON will provide applicable third party certification documents identifying ratings and limitations of use that apply to the products. This information by itself is not sufficient for a complete determination of the suitability of the products in combination with the end product, machine, system, or other application or use.

The following are some examples of applications for which particular attention must be given. This is not intended to be an exhaustive list of all possible uses of the products, nor is it intended to imply that the uses listed may be suitable for the products:

- Outdoor use, uses involving potential chemical contamination or electrical interference, or conditions or uses not described in this document.

- Nuclear energy control systems, combustion systems, railroad systems, aviation systems, medical equipment, amusement machines, vehicles, safety equipment, and installations subject to separate industry or government regulations.
- Systems, machines, and equipment that could present a risk to life or property.

Please know and observe all prohibitions of use applicable to the products.

NEVER USE THE PRODUCTS FOR AN APPLICATION INVOLVING SERIOUS RISK TO LIFE OR PROPERTY WITHOUT ENSURING THAT THE SYSTEM AS A WHOLE HAS BEEN DESIGNED TO ADDRESS THE RISKS, AND THAT THE OMRON PRODUCT IS PROPERLY RATED AND INSTALLED FOR THE INTENDED USE WITHIN THE OVERALL EQUIPMENT OR SYSTEM.

PERFORMANCE DATA

Performance data given in this document is provided as a guide for the user in determining suitability and does not constitute a warranty. It may represent the result of OMRON's test conditions, and the users must correlate it to actual application requirements. Actual performance is subject to the OMRON Warranty and Limitations of Liability.

CHANGE IN SPECIFICATIONS

Product specifications and accessories may be changed at any time based on improvements and other reasons.

It is our practice to change model numbers when published ratings or features are changed, or when significant construction changes are made. However, some specifications of the product may be changed without any notice. When in doubt, special model numbers may be assigned to fix or establish key specifications for your application on your request. Please consult with your OMRON representative at any time to confirm actual specifications of purchased products.

DIMENSIONS AND WEIGHTS

Dimensions and weights are nominal and are not to be used for manufacturing purposes, even when tolerances are shown.

ERRORS AND OMISSIONS

The information in this document has been carefully checked and is believed to be accurate; however, no responsibility is assumed for clerical, typographical, or proofreading errors, or omissions.

PROGRAMMABLE PRODUCTS

OMRON shall not be responsible for the user's programming of a programmable product, or any consequence thereof.

COPYRIGHT AND COPY PERMISSION

This document shall not be copied for sales or promotions without permission.

This document is protected by copyright and is intended solely for use in conjunction with the product. Please notify us before copying or reproducing this document in any manner, for any other purpose. If copying or transmitting this document to another, please copy or transmit it in its entirety.

Precautions for Safe Use

Always observe the following precautions to ensure safety.

■ Environment

- Do not use the Smart Sensor in locations subject to explosive or flammable gases.
- To ensure safety in operation and maintenance, do not install the Smart Sensor near high-voltage equipment or power devices.

■ Power Supply and Wiring

- Do not impose voltages exceeding the rated voltage (12 to 24 VDC $\pm 10\%$).
- When supplying power to the Sensor, make sure that the polarity of the power is correct, and do not connect to an AC power supply.
- Do not short-circuit the load for the open collector output.
- Do not lay the power supply cable for the Smart Sensor together with high-voltage lines or power lines. Doing so, or placing them into the same duct, can cause induction and lead to malfunction or damage.
- Always turn OFF the power supply before wiring and before connecting or disconnecting connectors.

■ Settings

- When setting the threshold value with the Smart Sensor connected to an external device, turn ON the Amplifier Unit's judgement output hold input to prevent the judgement from being output to the external device.

■ Others

- The ZX-L-series Smart Sensors (Laser Type), ZX-W-series Smart Sensors (Microwave Type), and ZX-T-series Smart Sensors (High-precision Contact Type) are not compatible. Do not use ZX-L-series, ZX-W-series, or ZX-T-series Smart Sensors together with ZX-E-series Smart Sensors.
- Do not attempt to disassemble, repair, or modify the Smart Sensor.
- When disposing of the Smart Sensor, treat it as industrial waste.

Precautions for Correct Use

Always observe the following precautions to prevent operation failures, malfunctions, and adverse effects on performance and equipment.

Smart Sensor Installation

■ Environment

Do not install the Smart Sensor in the following locations:

- Locations where the ambient temperature exceeds the rated temperature range
- Locations subject to rapid changes in temperature (causing condensation)
- Locations where the relative humidity exceeds the range of 35% to 85%
- Locations subject to corrosive or flammable gases
- Locations where dust, salt, or metallic powder accumulate on the Sensor
- Locations subject to direct vibration or impact
- Locations subject to direct sunlight
- Locations subject to exposure to water, oil, chemicals, etc.
- Locations subject to strong electromagnetic or electrical fields
- Locations subject to water vapor

Installation and Handling of Components

■ Power Supply and Wiring

- Do not extend the Sensor Head cable by more than 8 m. Use a ZX-XC□A Extension Cable (order separately) to extend the cable from the Sensor.
- Use a shielded cable to extend the Amplifier cable. The shielded cable must have the same specifications as that of the Amplifier cable.
- When using a commercially available switching regulator, ground the FG (frame ground) terminal.
- If the power supply line is subject to surges, connect a surge absorber that meets the conditions of the application environment.
- When connecting multiple Amplifier Units, connect the linear grounds of all the Amplifier Units.

■ Warm-up

After turning ON the power, allow the Smart Sensor to warm up for 30 minutes minimum prior to use. The circuitry is not stable immediately after turning the power ON, and the values gradually change until the Sensor is completely warmed up.

■ Maintenance and Inspection

- Always turn OFF the power supply before adjusting or removing the Sensor Head.
- Do not use thinners, benzene, acetone, or kerosene to clean the Sensor Head or Amplifier Unit.

How to Use This Manual

Page Format

Section 3 Basic Operations

Section Title
Indicates page contents.

Main Heading in a Section
Indicates page contents.

Section 3 Adjusting Linearity

Outline
Provides an outline or gives a flowchart of the operation described under the main heading.

Sub-heading
Provides an outline or gives a flowchart of the operation described under the main heading.

Index Label
Gives the section number and subject matter.

Function Outline and Suggestions
Gives the section number and subject matter.

Operation
Indicates the operation to be performed next.

Adjusting Linearity

ZX-E Smart Sensor linearity is adjusted before shipment, however more accurate linearity can be obtained by adjusting linearity again for the actual sensing objects and operating environment.

Selecting Sensing Object Material

This section describes how to set the sensing object material.

To use the default linearity adjustment after changing materials, select the material and then select Adjust.

CHECK! p.117

Changing to T Mode

- Set the mode switch to T.
- Set the switch to the threshold value to be set.
- Press any Cursor Key.
The first digit of the threshold value displayed on the sub-display will flash and direct input will be enabled.
- Change the threshold value with the Cursor Keys.
To cancel the selected setting, use the LEFT Key to move the cursor to the leftmost digit and press the LEFT Key again. The display will return to the current setting.

Operation Manual | 31

Display Area
Shows the display status after a step in an operation.

Keys and Switches
Provides an illustration of the keys or switches used during the operation.

Procedure and Additional Explanations
Information useful during the operation and reference pages are provided here with special marks to indicate the kind of information being provided.

* This page does not actually exist in this manual.

Notation

■ Menus

Items that appear on the digital displays are set in ALL-CAPS.

■ Procedures

The order for the procedures is indicated by numbered steps.

■ Visual Aids



Provides information on important operating procedures, gives advice on how to use functions, and highlights important performance information.



Indicates pages with relevant information.



Indicates useful information for when problems arise.

Section 1

FEATURES

 ZX-E Features

16

ZX-E Features

The ZX-E Smart Sensor measures the distance between the Sensor Head and the sensing object.

Example: Detecting the Bottom Deadpoint on a Press Machine

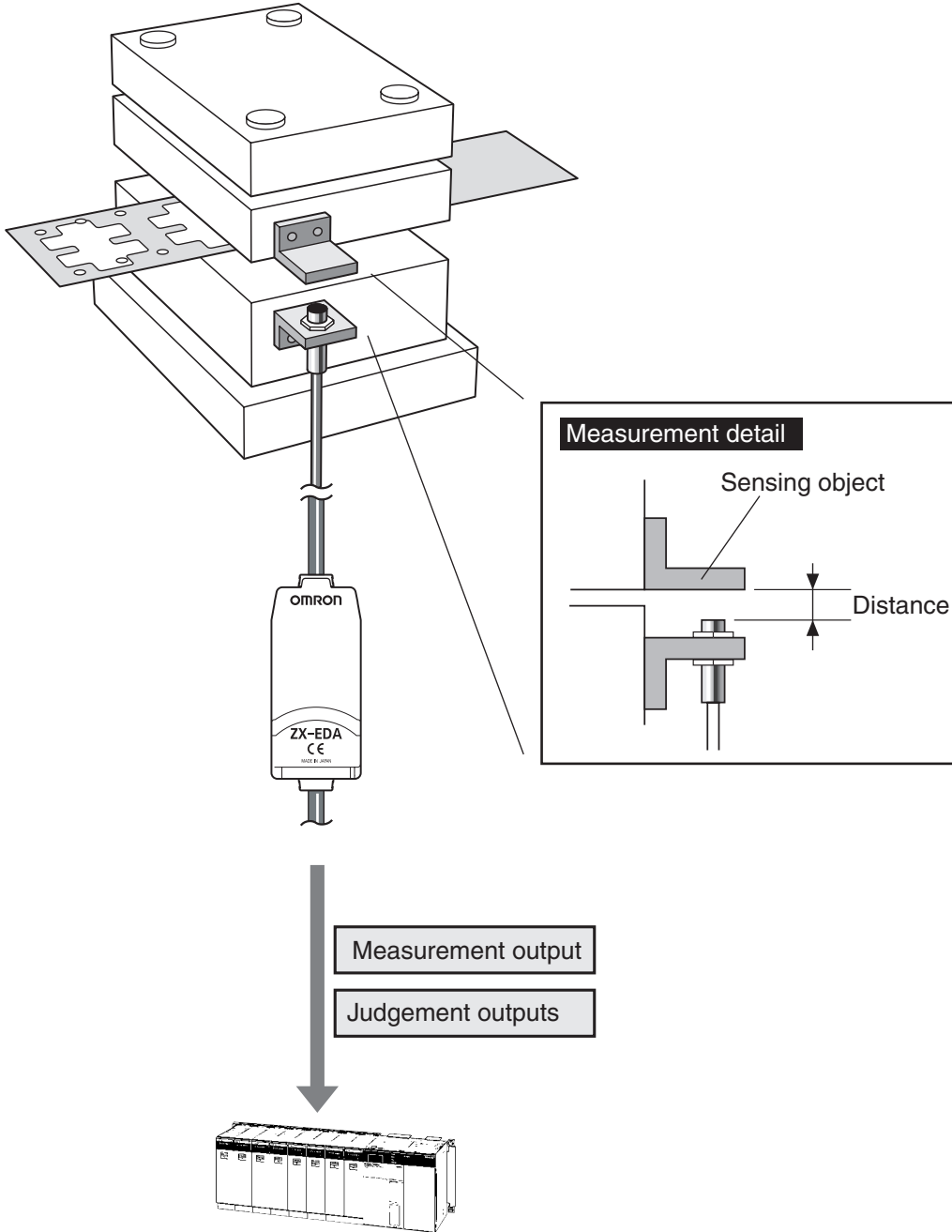

Useful Notification Function

■ Warming Up Display

The display shows the warming-up status when the power is turned ON. This enables measurements to be started when the status has stabilized after warming up has been completed.

 See page 41.

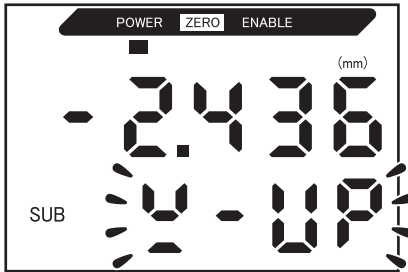

The sub-display flashes *W-UP* during warm-up.

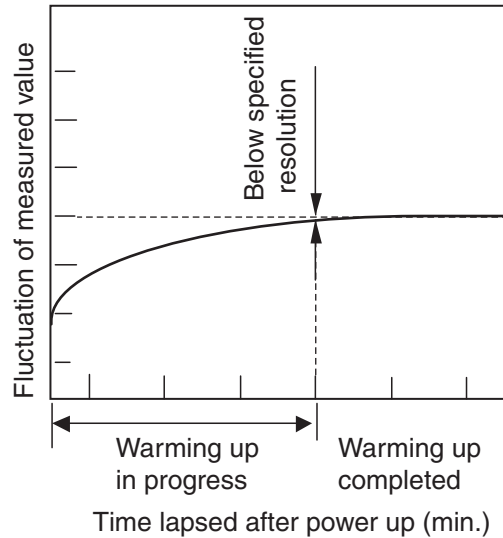

Many, Simple Functions

■ Measurement Ready at Power ON

The Smart Sensor can be used simply by installing and wiring it. Simply turn ON the power and it's ready to operate.

The measurement distance is displayed on the Amplifier Unit.

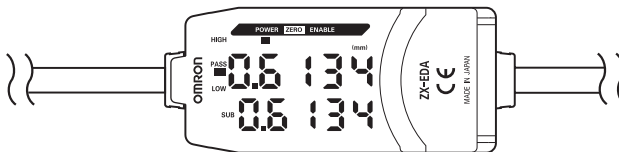

■ Simple Linearity Adjustment

Place the sensing object at specified distances and simply press the ENT Key to execute precise linearity adjustment. Time-consuming offset and range adjustments are not required.

Precise adjustment is also possible for non-ferrous sensing objects.

 p. 54

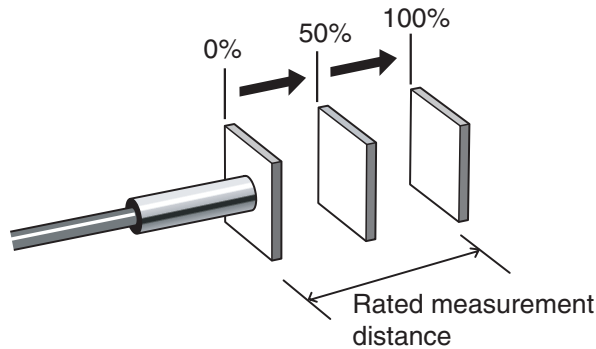

■ Simple Calculation Settings

Use a Calculating Unit to simply measure thickness and sum and difference calculations between two measurements.

 p. 116

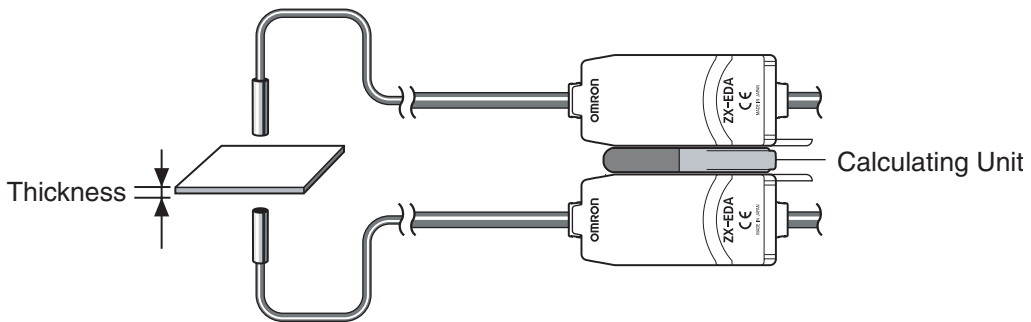

Mutual Interference Prevention for Closely Mounted Sensor Heads

The Smart Sensor has a mutual interference prevention function which allows multiple Sensor Heads to be mounted close to each other. This function is supported for up to five Sensor Heads by using ZX-CAL2 Calculating Units.

 p. 26 and p. 120

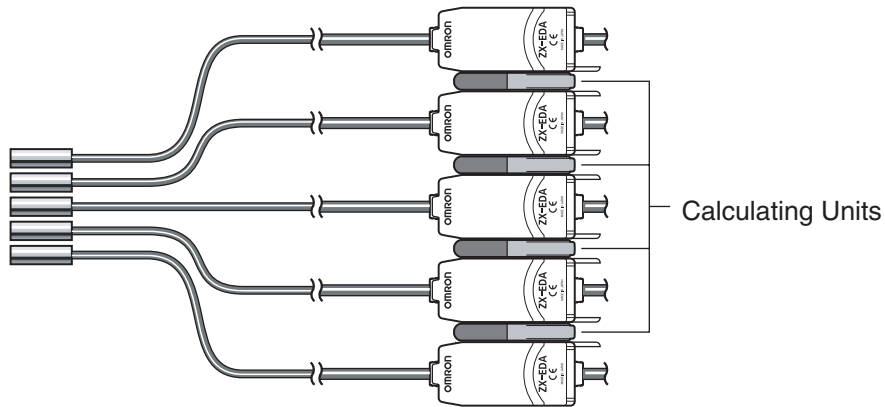

Compatibility between Sensor Heads and Amplifier Units

Amplifier Units do not need to be changed when Sensor Heads are changed for maintenance or to switch to new products.

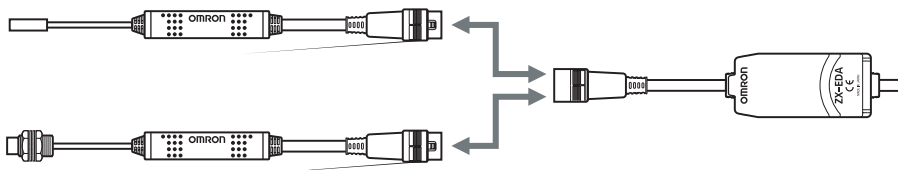

Extendable Sensor Head Cables

An extension cable with a maximum length of 8 m can be connected. The ZX-XC-A Extension Cable is required to extend the Sensor Head cable.

 p. 24

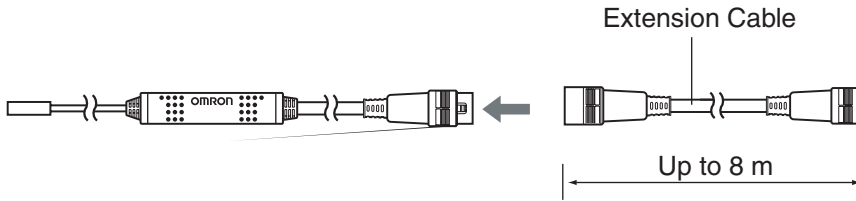

Monitoring Measurement Status

Resolution Display for Sensing Object

The resolution can be displayed, allowing judgements to be made about detection margins while viewing the resolution value.

 p. 51

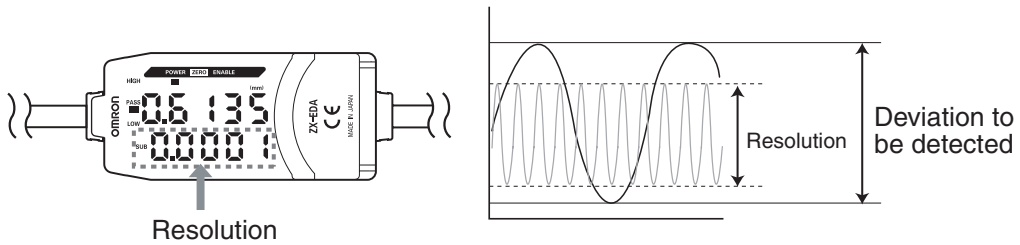

Confirm Measurement Status on a Personal Computer





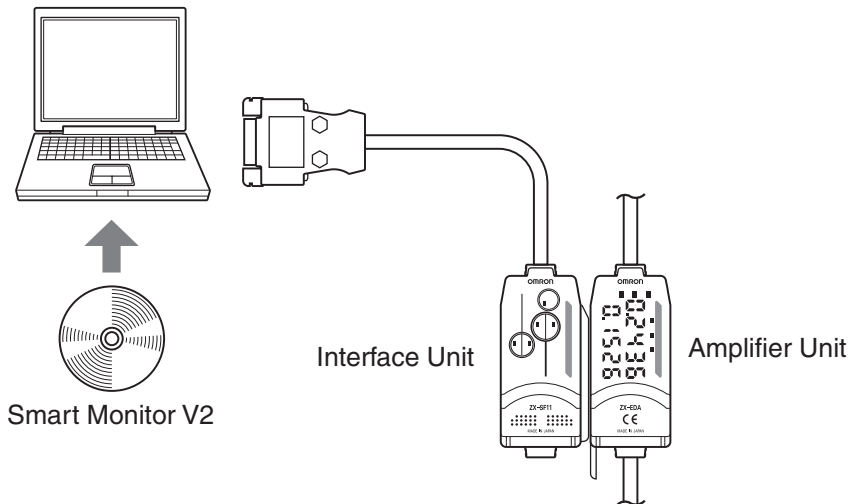

Use an Interface Unit and Smart Monitor V2 to view measurement waveforms and log measurement data on a personal computer. This function is useful for making on-site measurement adjustments and for day-to-day quality control.

 p. 24



Section 2

PREPARATIONS FOR MEASUREMENT

 Basic Configuration	24
 Part Names and Functions	25
 Installing the Amplifier Unit	28
 Installing Sensor Heads	30
 Connections	34
 Wiring Output Cables	38

Basic Configuration

The basic configuration of the ZX-E-series Smart Sensors is shown below.



ZX-L-series Smart Sensors (Laser Type) and ZX-E-series Smart Sensors (Inductive Displacement Type) are not compatible. Do not use ZX-L-series and ZX-E-series Smart Sensors together.

CHECK!

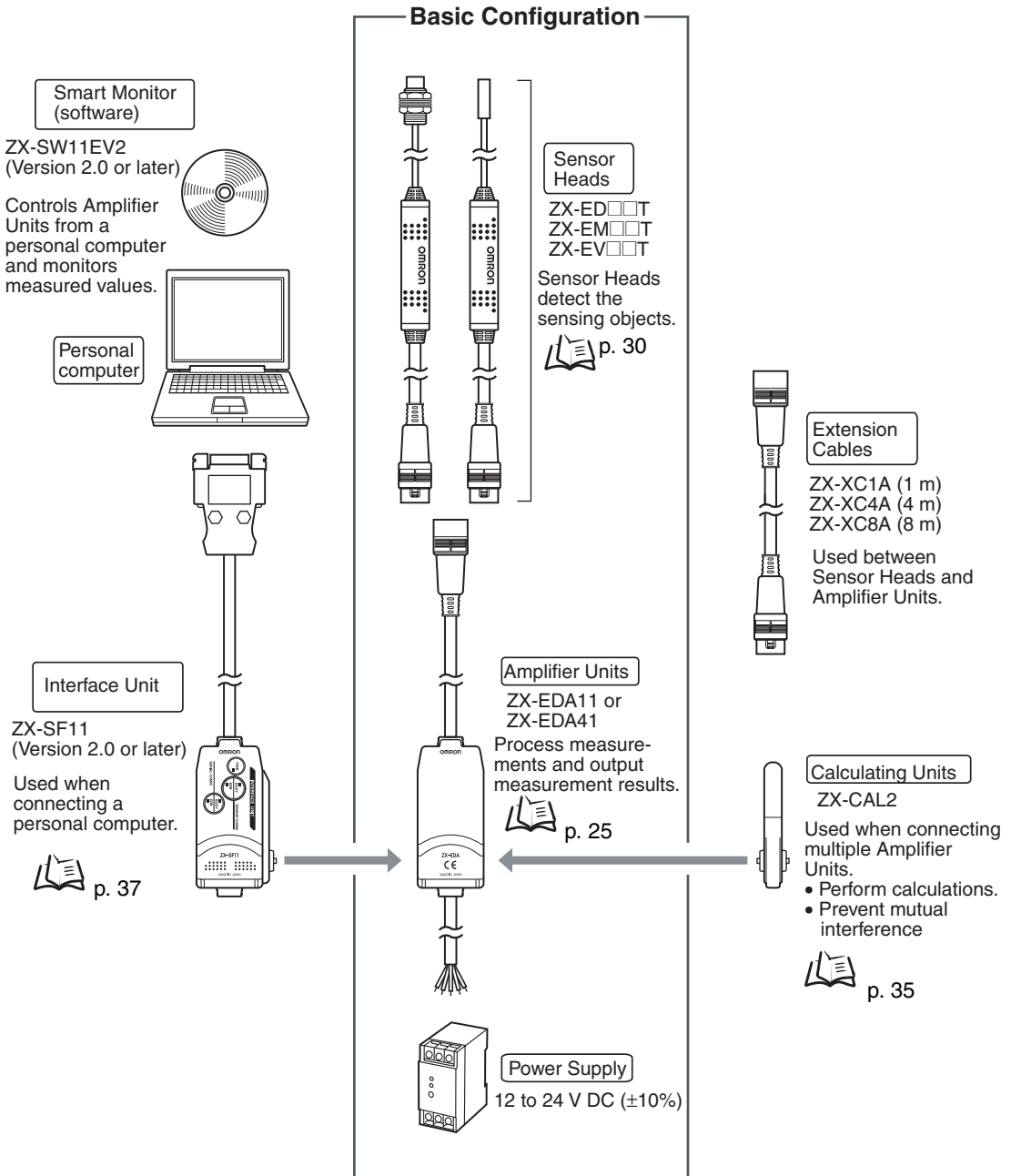

Part Names and Functions

Amplifier Units

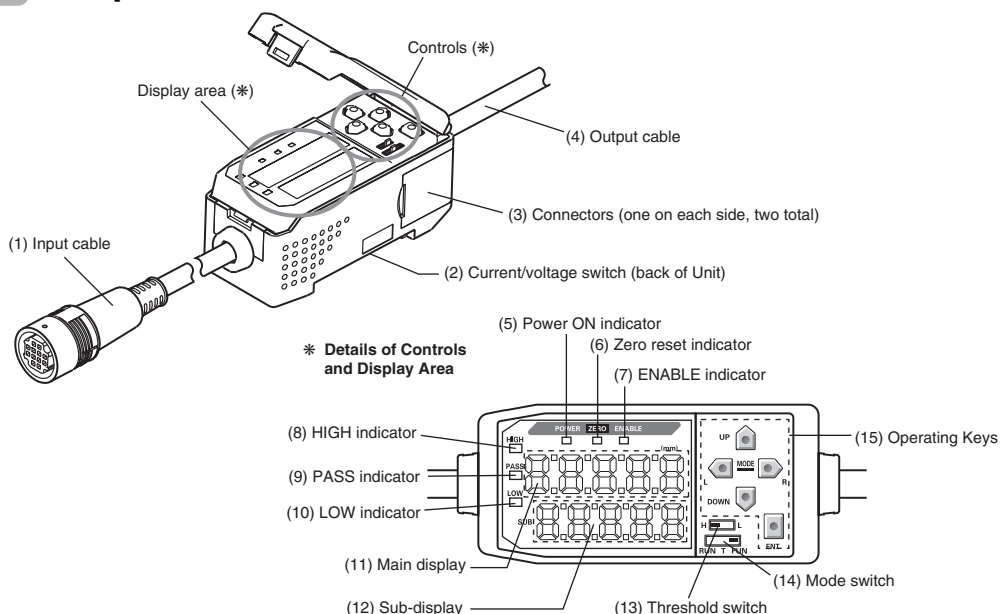

- (1) The input cable connects the Sensor Head.
- (2) The current/voltage switch selects either a current or voltage linear output.

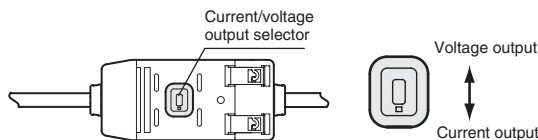

Monitor focus settings are also required when switching the output. p. 103

- (3) The connectors connect Calculation and Interface Units.
- (4) The output cable connects to the power supply and external devices, such as sync sensors or programmable controllers.
- (5) The Power ON indicator lights when the power is turned ON.
- (6) The Zero Reset indicator lights when the zero reset function is enabled.
- (7) The ENABLE indicator lights when the measurement result is within the measurement distance.
- (8) The HIGH indicator lights when the judgement result is HIGH.
- (9) The PASS indicator lights when the judgement result is PASS.
- (10) The LOW indicator lights when the judgement result is LOW.
- (11) The main display shows measured values and function names.
- (12) The sub-display shows additional information and function settings for measurements. Reading Displays, p. 47
- (13) The threshold switch selects whether to set (and display) the HIGH or LOW threshold.
- (14) The mode switch selects the operating mode. Switching Modes, p. 46
- (15) The Control Keys set measurement conditions and make other settings.

Key Operations, p. 48

Sensor Heads

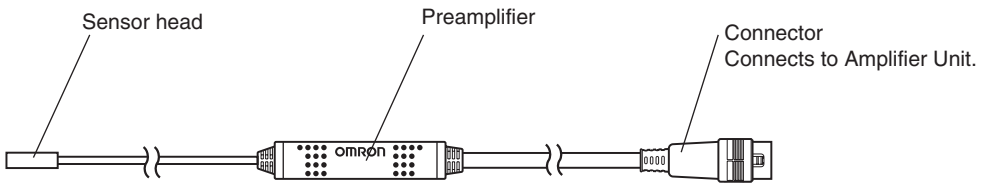

Calculating Units

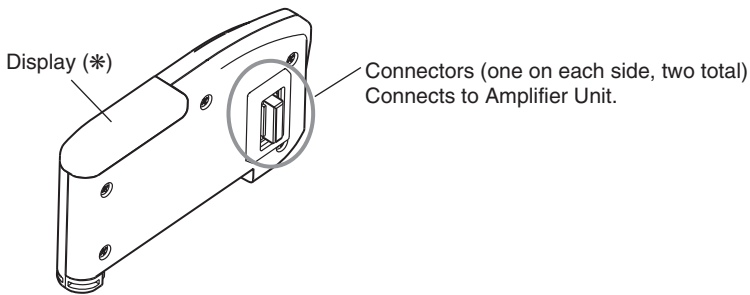

* Display Detail

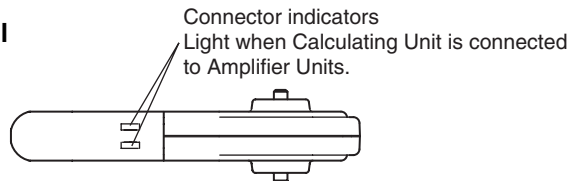

Interface Units

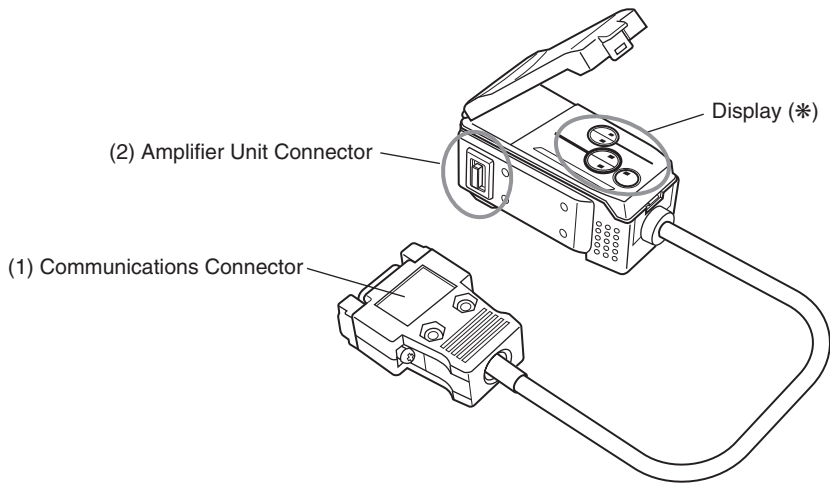

* Display Detail

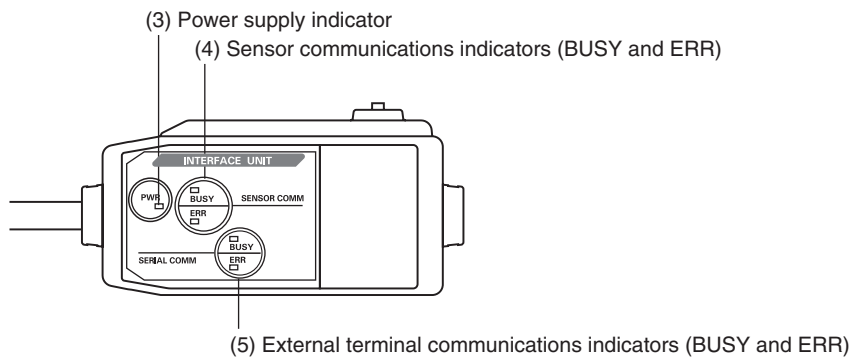

- (1) The communications connector connects the communications cable to the computer.
- (2) The Amplifier Unit connector connects to the Amplifier Unit.
- (3) The power supply indicator lights when the power is turned ON.
- (4) BUSY: Lights during communications with the Smart Sensor.
ERR: Lights if an error occurs during communications with the Smart Sensor.
- (5) BUSY: Lights during communications with the personal computer.
ERR: Lights if an error occurs during communications with the computer.

Installing the Amplifier Unit

Amplifier Units can be easily mounted to 35-mm DIN Track.

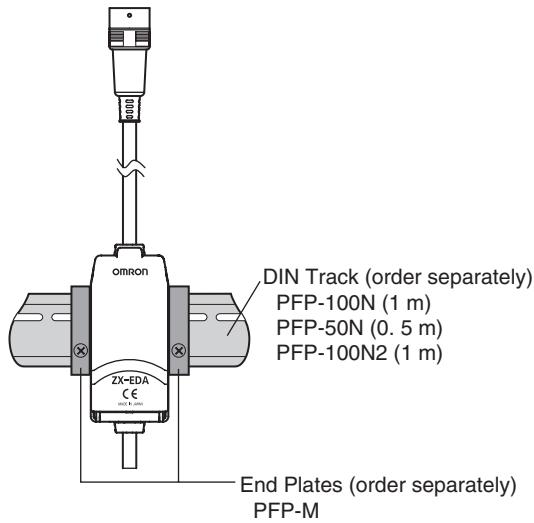

■ Installation

Hook the connector end of the Amplifier Unit on the DIN Track and press in at the bottom until the Unit locks into place.

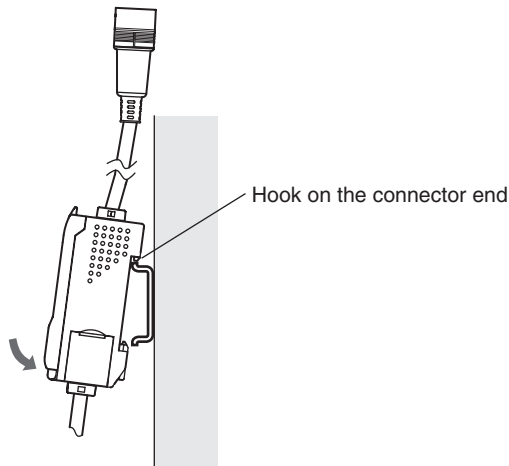

Always hook the connector end of the Amplifier Unit on the DIN Track first. Mounting strength may decrease if the output cable end is hooked on the DIN Track first.

■ Removal Method

Push the Amplifier Unit up and pull out from the connector end.

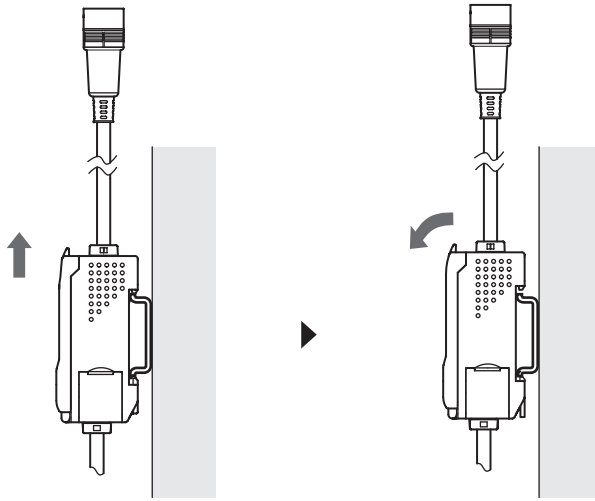

Installing Sensor Heads

This section describes how to install Sensor Heads and Preamplifiers.

Sensor Heads

■ Installation

■ ZX-ED□□T Sensor Heads (Non-threaded Type)

Mounting Bracket (order separately)

Y92E-F5R4 (for 5.4 mm dia.)



When using a set screw, tighten the screw to a torque of 0.2 N·m or less.

Mount the Sensor Head as shown in the following diagram.

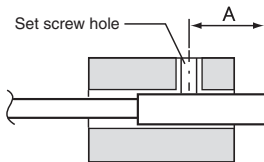

(Unit: mm)

Model	A
ZX-EDR5T	9 to 18
ZX-ED01T	9 to 18
ZX-ED02T	11 to 22

■ ZX-EM□□T Sensor Heads (Threaded Type)

The tightening torque for the threaded type (ZX-EM□□T) is shown in the following table.

Model	Strength (torque)
ZX-EM02T	15 N·m
ZX-EM07MT	
ZX-EM02HT	5.9 N·m



CHECK!

When using the ZX-EM02HT, consider the thermal expansion caused by the rise in temperature of the sensing object, and make sure that the sensing object does not touch the sensing surface.

Even when operated within the specified temperature range, using in locations subject to extreme temperature fluctuations may result in deterioration of Sensor characteristics.



CHECK!

When using the ZX-EM02HT, make sure that the bending radius of the cable from the Sensor Head is 8 mm or greater .

■ Installation Distance

Mount the Sensor Head so that the distance between the Sensor Head and the sensing object is approximately half of the measurement distance.

Example: ZX-ED01T Sensor Head

Measurement distance: 0 to 1 mm

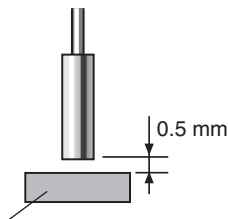

Sensing object: Ferrous object 18 × 18 mm or larger



Use a ferrous sensing object larger than a standard sensing object. If a smaller-than-standard sensing object or a non-ferrous object is used, the predetermined characteristics may not be obtained.

Characteristic Data, p. 148

■ Influence of Surrounding Metal

Separate the Sensor Head from surrounding metals by at least the distances shown in the following diagram.

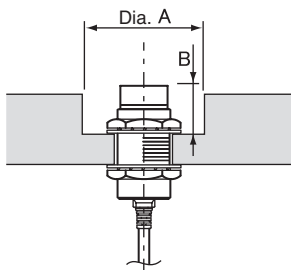

(Unit: mm)

Model	Dia. A	B
ZX-EDR5T	8	9
ZX-ED01T	10	9
ZX-ED02T	12	9
ZX-EM02T	12	9
ZX-EM07MT	55	20
ZX-EV04T	16×32	4.8
ZX-EM02HT	18	9

■ Mutual Interference

When using multiple Sensor Heads, separate each Sensor Head by the minimum distances shown in the following diagram.



The distance between Sensor Heads can be further reduced when the Sensor Heads are side by side if the mutual interference prevention function is used.

Performing Calculations, p. 116

- Face to face

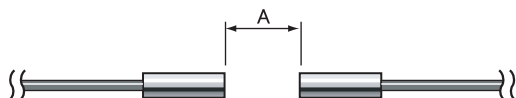

- Side by side

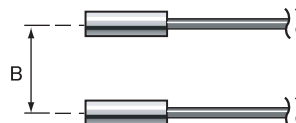

(Unit: mm)

Model	A	B	
		Mutual Interference Prevention Function	
		Used	Not used
ZX-EDR5T	5	3.1	20
ZX-ED01T	10	5.4	50
ZX-ED02T	20	8	50
ZX-EM02T	20	10	50
ZX-EM07MT	100	30	150
ZX-EV04T	80	14	50
ZX-EM02HT	20	12	50

Preamplifiers

■ Installation

Use the enclosed Preamplicifier Mounting Bracket.



The Preamplicifier can also be mounted to 35-mm DIN Track.

Use the ZX-XBE2 Preamplicifier DIN Track Mounting Bracket (order separately) when mounting the Preamplicifier to DIN Track.

1. Use M3 screws to fix the enclosed Preamplicifier mounting bracket.

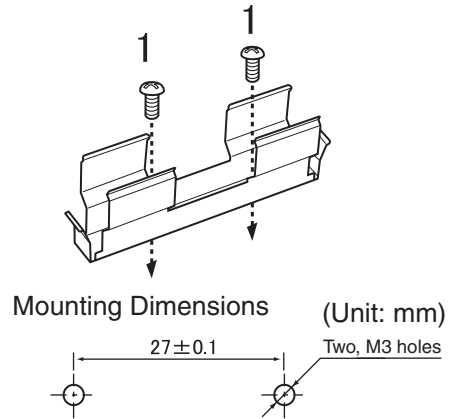

2. Snap one end of the Preamplicifier into the bracket.
3. Then snap the other end of the Preamplicifier into the bracket.

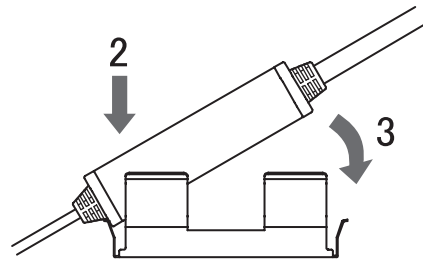

■ Removal Method

Hold the center of the Preamplicifier and lift.

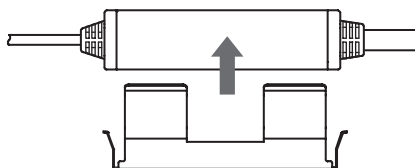

Connections

This section describes how to connect component parts of the Smart Sensor.



Turn OFF the power supply to the Amplifier Unit before connecting or removing components. The Smart Sensor may malfunction if components are connected or removed while the power is ON.

CHECK!



Sensor Heads



Do not touch the terminals inside the connector.

CHECK!

■ Connection Method

Push the Sensor Head connector into the Amplifier Unit connector until it locks.

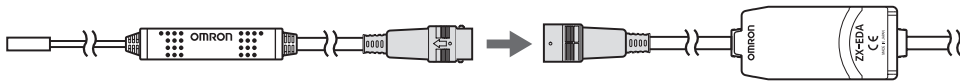

■ Removal Method

When disconnecting the Sensor Head, hold the connector ring and the Amplifier Unit connector and pull them straight out.



Do not pull only on the connector ring, because the input cable of the Amplifier Unit may be damaged.

CHECK!

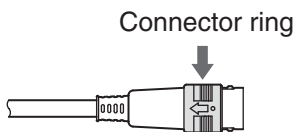

All settings on the Amplifier Unit will be cleared when the Sensor Head is replaced with a different model.

CHECK!

Calculating Units

Use a Calculating Unit to connect Amplifier Units when making calculations between Amplifier Units and to prevent mutual interference between Sensor Heads.

The number of Amplifier Units that can be joined depends on the functions being used.

Function	No. of Connectable Amplifier Units
Calculation	2
Mutual interference prevention	5



Provide power to all connected Amplifier Units.

CHECK!

■ Connection Method

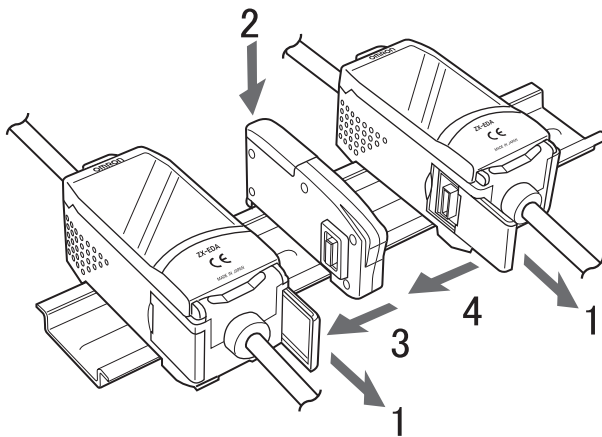

- 1.** Open the connector covers on the Amplifier Units.
Open the connector covers by lifting and sliding them open.
- 2.** Mount the Calculating Unit to the DIN Track.
- 3.** Slide and connect the Calculating Unit to the Amplifier Unit connector.
- 4.** Slide and connect the second Amplifier Unit to the Calculating Unit connector.

Perform the above operation in the reverse order to remove Calculating Units.

■ Channel Numbers of Amplifier Units

The following diagram shows the channel numbers when multiple Amplifier Units are connected.

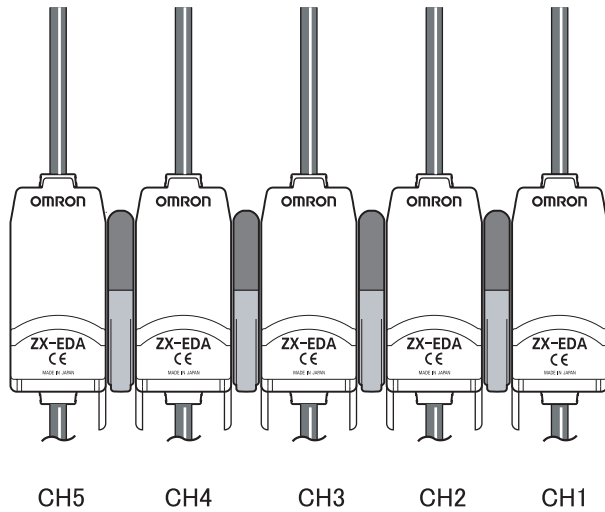

Interface Units

Use an Interface Unit to connect a personal computer to the Smart Sensor system.

■ Connection Method

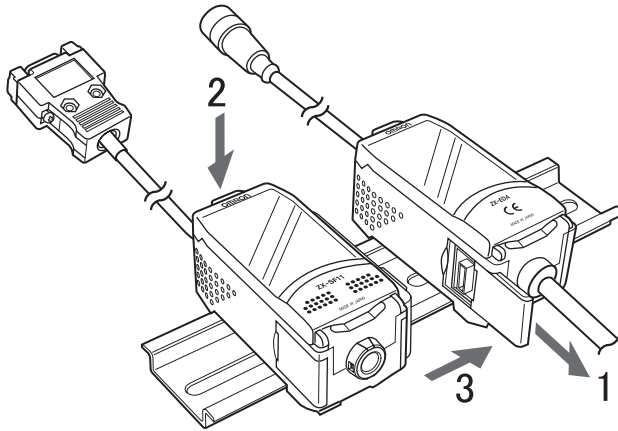

- 1.** Open the connector cover on the Amplifier Unit.
Open the connector cover by lifting and sliding it open.
- 2.** Mount the Interface Unit to the DIN Track.
- 3.** Slide and connect the Interface Unit to the Amplifier Unit connector.

Perform the above operation in the reverse order to remove Interface Units.



When multiple Amplifier Units are used, connect the Interface Unit to the Amplifier Unit with the highest channel number.

CHECK!

Wiring Output Cables

The following diagram shows the wires in the output cable.



Wire the output cable correctly. Incorrect wiring may damage the Smart Sensor.

CHECK!

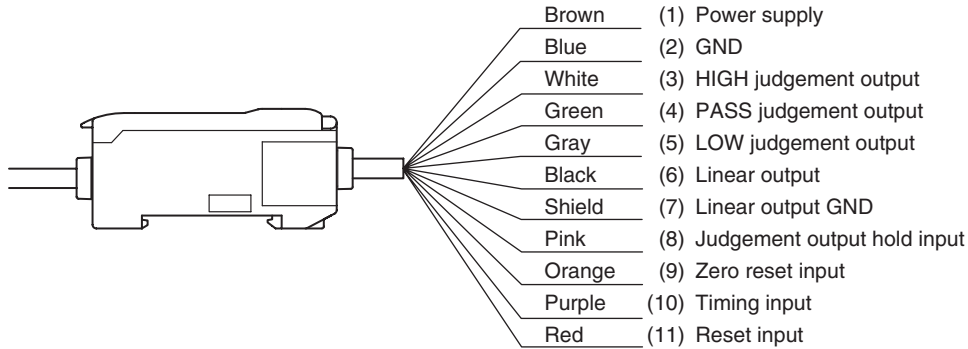

- (1) A 12- to 24-VDC ($\pm 10\%$) power supply is connected to the power supply terminals. When using an Amplifier Unit with a PNP output, the power supply terminal is also the common I/O terminal for all I/O except for the linear output.



Use a stabilized power supply separate from other devices and power systems for the Amplifier Unit, particularly when high resolution is required.

CHECK!

- (2) The GND terminal is the 0-V power supply terminal. When using an Amplifier Unit with an NPN output, the GND terminal is also the common I/O terminal for all I/O except for the linear output.
- (3) The HIGH judgement output outputs HIGH judgement results.
- (4) The PASS judgement output outputs PASS judgement results.
- (5) The LOW judgement output outputs LOW judgement results.
- (6) The linear output outputs a current or voltage output in accordance with the measured value.
- (7) The linear output GND terminal is the 0-V terminal for the linear output.



- Use a different ground for the linear output from the normal ground.
- Always ground the linear output terminal even when linear output is not used.

CHECK!

- (8) When the judgement output hold input is turned ON, the judgement outputs are held and not output to the external devices. Turn the judgement output hold input ON when setting threshold values.



When setting threshold values while connected to external devices, turn ON the Amplifier Unit's judgement output hold input to prevent the outputs to external devices from changing.

CHECK!

- (9) The zero reset input is used to execute and clear zero reset.
- (10) The timing input is for signal input from external devices. Use it for hold function timing.
- (11) The reset input resets all measurement processing and outputs.

I/O Circuit Diagrams

■ NPN Amplifier Unit

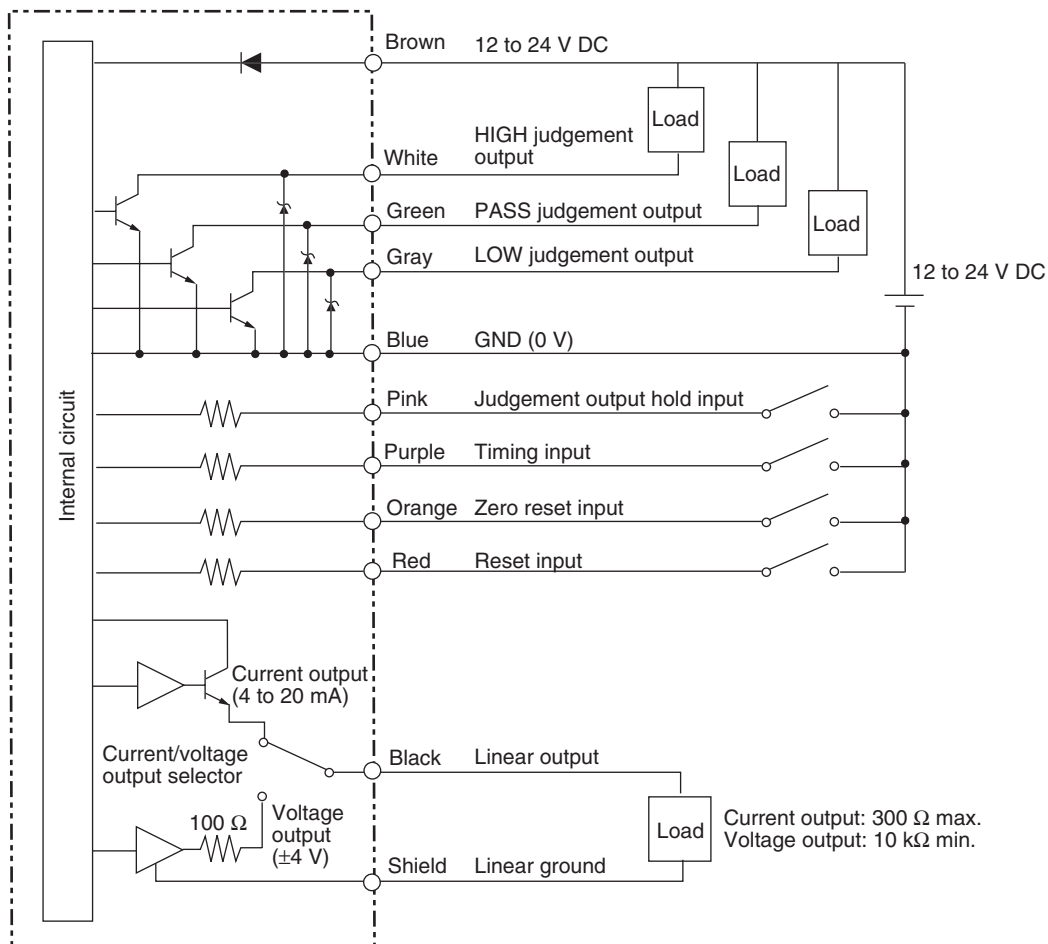

■ PNP Amplifier Unit

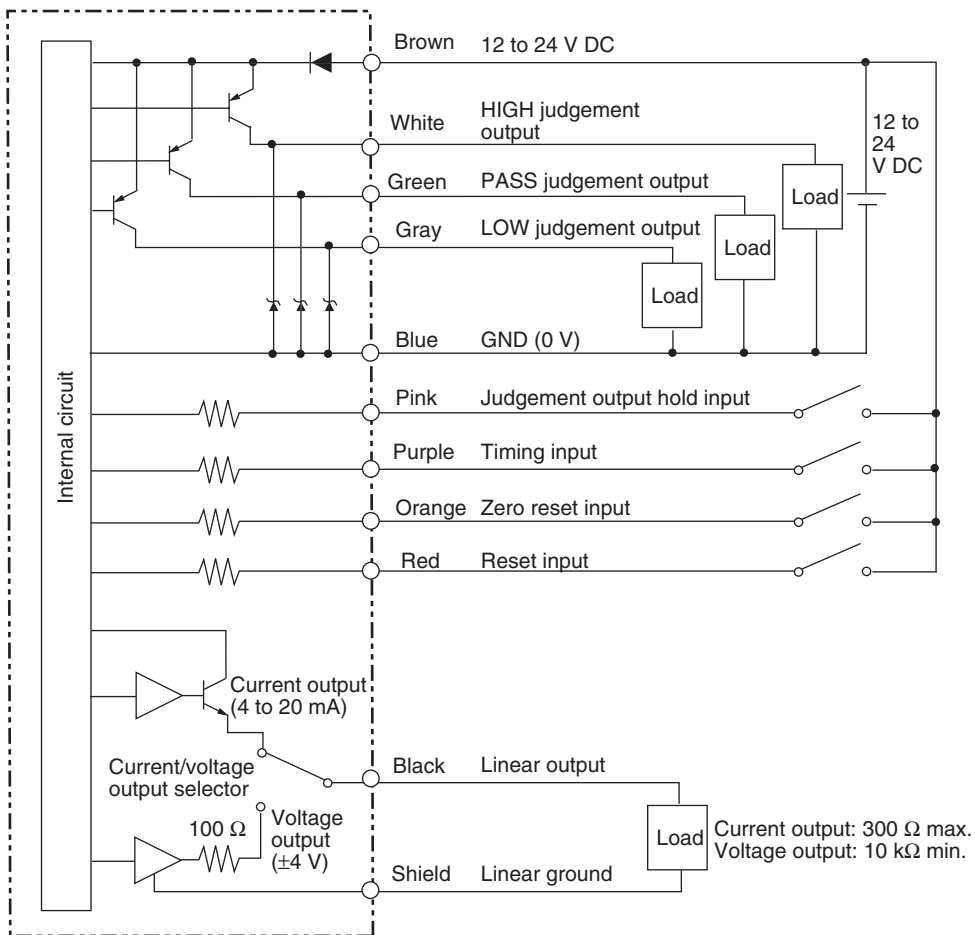

Confirming Warm-up Completion

When the power is turned ON in RUN or T Mode, the sub-display will flash *W-UP* to show that the Sensor is warming up. Warm-up requires approximately 5 to 15 minutes. When warming up has been completed, the normal display will be shown.



Measurement operations can be performed while in warm-up display status, but the precision of measurements before warming up has been completed will be low. For high-precision measurements, wait until warming up has been completed.

Section 3

BASIC OPERATION

☒	Flow of Operation	44
☒	Basic Knowledge for Operation	46
	Switching Modes	46
	Reading Displays	47
	Key Operations	48
	Setting Conditions	49
	Inputting Numerals	50
☒	Function Transition Charts	51
☒	Adjusting Linearity	54
	Selecting Sensing Object Material	54
	Entering Adjustment Values	56
	Executing Adjustment	58
	Initializing Adjustment Settings	59

Flow of Operation

Preparations for Measurement

Installation and Connection



Preparations for Measurement p. 23

Turn ON Power Supply



CHECK!



Reading Displays and Operating

Basic Knowledge for Operation p. 46

Setting Measurement Conditions to Executing Measurements

Adjusting Linearity



Adjusting Linearity p. 54

Making Settings for the Application



Detecting Bottom Deadpoint p. 62
Measuring Height p. 67
Measuring Eccentricity and Vibration p. 71
Measuring Thickness p. 74

Setting and Changing Measurement Data



Setting Number of Samples to Average p. 80
Using Hold Functions p. 81
Comparing Measured Values (Previous Value Comparison) p. 88
Changing Display Scales p. 90

Setting Judgement Conditions



Entering Threshold Values p. 97

Setting Output Data



Linear Output p. 103
Setting Judgement Output Timing (Timer) p. 112

If required Correcting the Measurement Reference Point



Using the Zero Reset Function p. 127



If Problems Occur



Abnormal Operation

Troubleshooting p. 136



Error Messages



Error Messages and Countermeasures

p. 137



Unknown Terms



Glossary p. 139



Meaning of Digital Display



Quick Reference for Digital Displays

p. 157

Applied Settings

Measuring with Multiple Amplifier Units



Performing Calculations p. 116
Preventing Mutual Interference between p. 120

Saving Zero Reset Level



p. 129

Setting Offset Values for Zero Reset



p. 128

Changing the Number of Display Digits



p. 123

Additional Functions

Using ECO Display Function



p. 126

Reversing the Display



p. 124

Key Lock Function



p. 132

Changing Settings

Initializing Settings Data



p. 133

Basic Knowledge for Operation

Switching Modes

The ZX-E has three modes. Use the Mode Switch on the Amplifier Unit to switch between modes. Switch to the desired mode before starting operation.

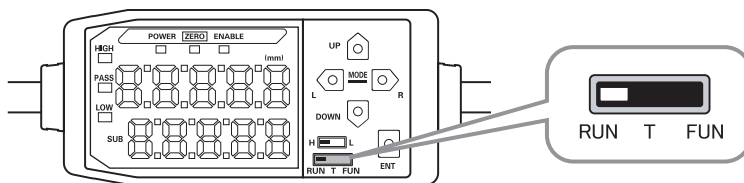





Mode	Description
RUN	Normal operation mode
T	Mode for setting the threshold values
FUN	Mode for setting measurement conditions

 Function Transition Charts, p. 51

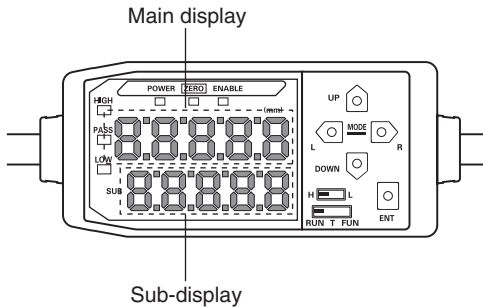
Reading Displays

The data displayed on the main and sub-displays depends on the mode currently selected. When the power is first turned ON after shipment, RUN mode data is displayed.



Mode	Main Display	Sub-display
RUN	Displays the measured value (the value after measurement conditions have been reflected.) For example, when the hold function is set, the held value will be displayed.	Changes between displaying the present value (actual measured value), threshold value, output value, and resolution in order when the Control Keys are pressed. Threshold Value Display Displays either the HIGH or LOW threshold value, depending on the position of the threshold switch.  The monitor focus setting determines whether the value is output as voltage or current.  Output Settings (Monitor Focus), p. 103
T	Displays the measured value (the value after the measurement conditions have been reflected). For example, when the hold function is set, the held value will be displayed.	Displays the threshold value for the threshold being set. Displays either the HIGH or LOW threshold value, depending on the position of the threshold switch. 
FUN	Displays the function names in order when the Control Keys are pressed.	Displays the setting for the function displayed on the main display.

 Function Transition Charts, p. 51

■ Alphabet Display Format

The alphabet appears on the main and sub-displays as shown in the following table.

A	B	C	D	E	F	G	H	I	J	K	L	M
Ⓐ	Ⓑ	Ⓒ	Ⓓ	Ⓔ	Ⓕ	Ⓖ	Ⓗ	Ⓘ	Ⓙ	Ⓚ	Ⓛ	Ⓜ
N	O	P	Q	R	S	T	U	V	W	X	Y	Z
Ⓝ	Ⓞ	Ⓟ	Ⓠ	Ⓡ	Ⓢ	Ⓣ	Ⓤ	Ⓥ	Ⓦ	Ⓧ	Ⓨ	Ⓩ



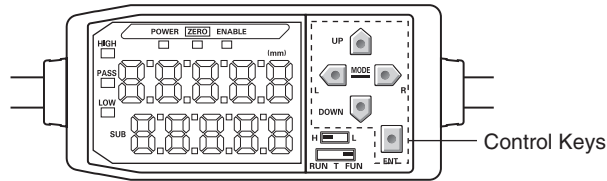

Key Operations

Use the Control Keys to change the display and set measurement conditions.



The mode currently selected determines the key functions.

 Switching Modes, p. 46

Key		Function		
		RUN Mode	T Mode	FUN Mode
Cursor Keys	 LEFT Key	Changes sub-display content.	Used when selecting numeral digits.	Function changes depending on setting. • Switches function display. • Selects numeral digit. • Stops setting.
	 RIGHT Key			
	 UP Key	Performs timing input.		
	 DOWN Key	Resets input.		
 ENT Key	Performs zero reset.	Function changes depending on operation. • Confirms threshold value. • Executes teaching.	Confirms the set condition or value.	

Setting Conditions

Display the target function on the main display and select the desired value from the sub-display to set measurement conditions.

This section uses the example of setting a peak hold as the hold condition to explain how to set measurement conditions.

Changing to FUN Mode and HOLD

1. Set the mode switch to FUN.



2. Use the LEFT and RIGHT Keys to display HOLD on the main display.

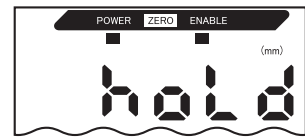

Setting Hold Conditions

3. Press either the UP or DOWN Key.

The present set value will flash on the sub-display.



4. Use the UP and DOWN Keys to select P-H.



Press either the LEFT or RIGHT Key to cancel the selected option. The display will return to the current setting (OFF in this example).



5. When you finish selecting the set value, press the ENT Key to confirm the setting.

The setting will be registered.



Inputting Numerals

This section describes how to input numeric values for threshold and output settings. The example of direct input of the low threshold value will be used.

Changing the low threshold from 0.2000 to 0.1900

Changing to T Mode

1. Set the mode switch to T.



Setting Threshold Value

2. Set the switch to L.

The measured value will be displayed on the main display. The current setting will be displayed on the sub-display.

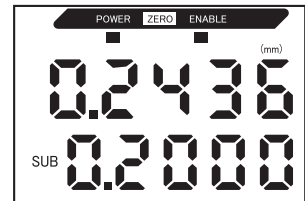

3. Press any Cursor Key.

The first digit on the sub-display will flash and direct input will be enabled.

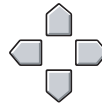

4. Use the LEFT or RIGHT Key to move the cursor to the first decimal place.



5. Use the UP or Down Key to display 1.



6. Repeat steps 4 and 5 to move the cursor to the second decimal place and display 9.

To cancel the selected setting, use the LEFT Key to move the cursor to the leftmost digit and press the LEFT Key again. Alternatively, use the RIGHT Key to move to the rightmost digit and press the RIGHT Key again. The display will return to the current setting (0.2000 in this example).



7. When you finish adjusting the numeric value, press the ENT Key to confirm the value.



The display will change from flashing to being lit continuously and the numeric value will be registered.

Function Transition Charts

Reading Transition Charts

The upper section is the main display and the lower section is the sub-display.

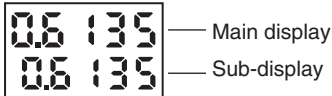

RUN Mode

Measured value (See note.) (The main display always shows the measured value.)

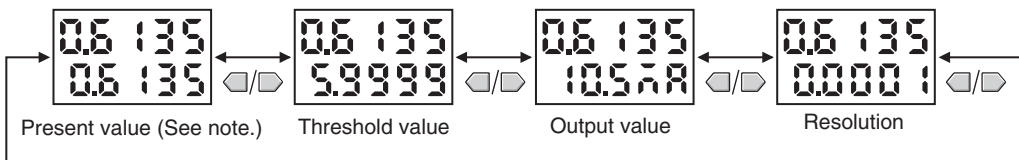

Note: In FUN mode, the measured value and present value are displayed first.

The numerals shown in the above diagram are an example only. The actual display may be different.

Present Values and Measured Values p. 139

T Mode

There is no function transition in T mode.

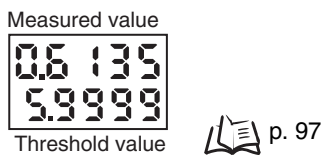

The numerals shown in the above diagram are an example only. The actual display may be different.



In RUN and T modes, the position of the threshold switch will determine whether the HIGH or LOW threshold will be displayed.

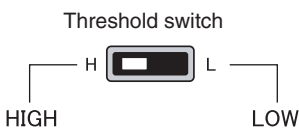

FUN Mode

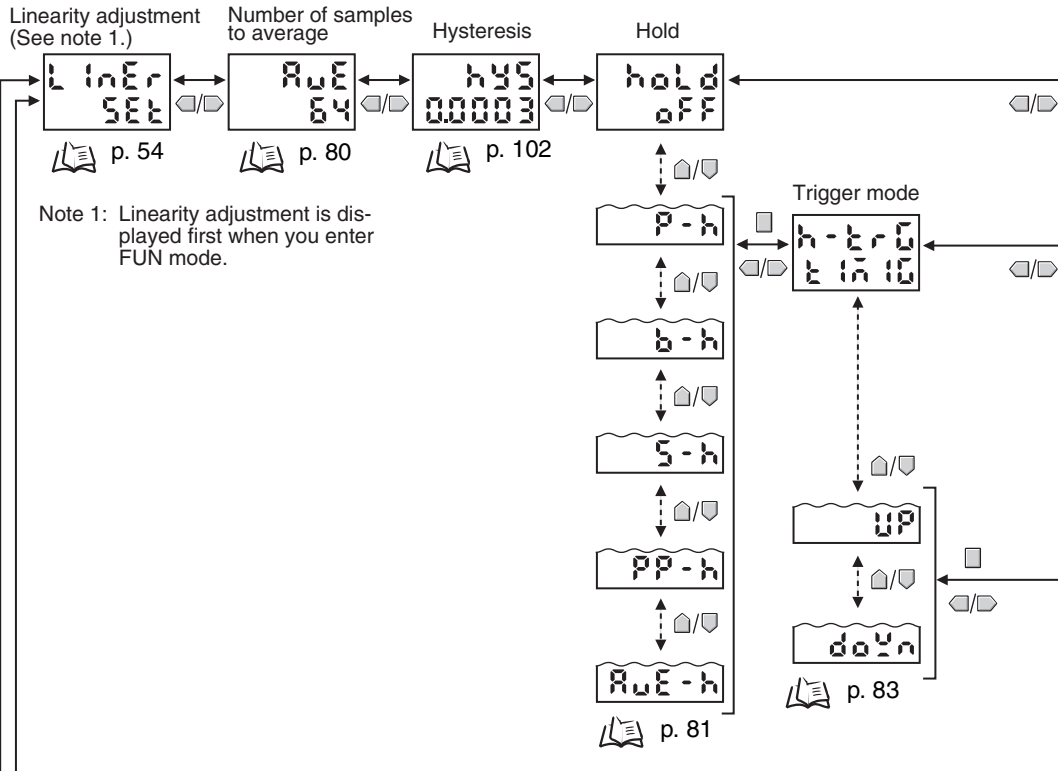

Special functions
When CLOSE is selected, the special functions will not be displayed and the display will return to LINER.

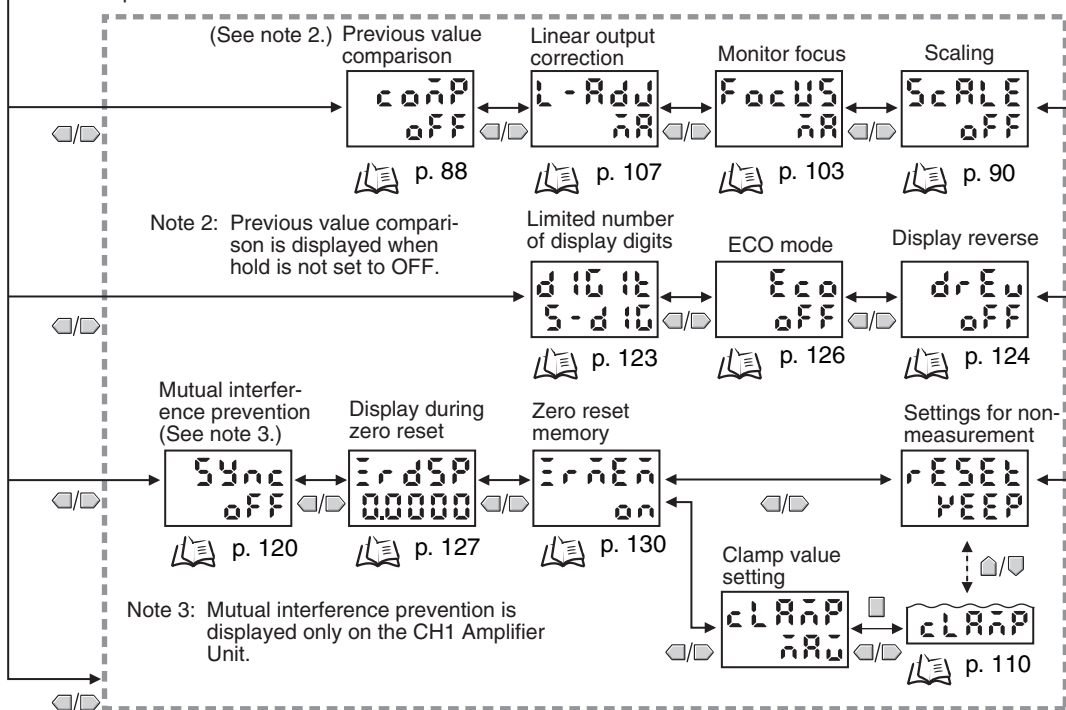

When ALL is selected, all special functions are displayed.

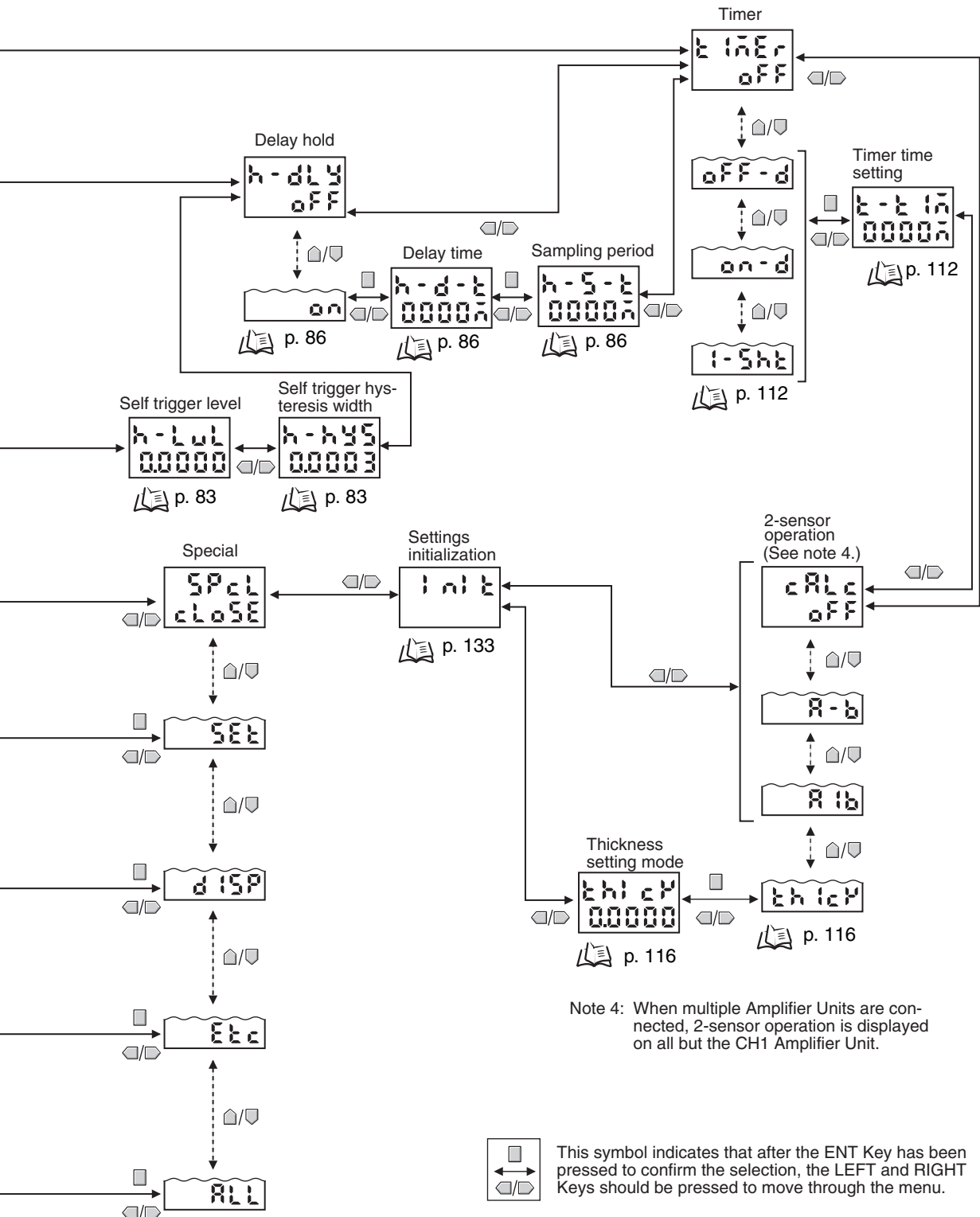

Note 4: When multiple Amplifier Units are connected, 2-sensor operation is displayed on all but the CH1 Amplifier Unit.

 This symbol indicates that after the ENT Key has been pressed to confirm the selection, the LEFT and RIGHT Keys should be pressed to move through the menu.

Adjusting Linearity

ZX-E Smart Sensor linearity is adjusted before shipment, however more accurate linearity can be obtained by adjusting linearity again for the actual sensing objects and operating environment.

Adjust linearity before setting measurement conditions. Linearity should also be adjusted again when Sensor Heads are replaced.

■ Flow of Operation

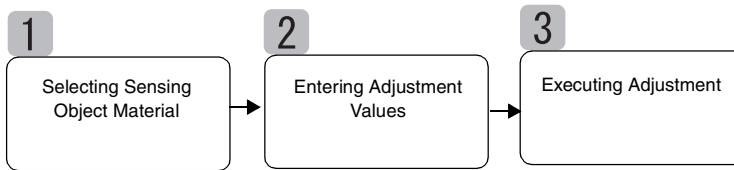

Linearity p. 139

1 Selecting Sensing Object Material

This section describes how to set the sensing object material.

Selection	Material
FE (default)	Iron
SUS	Stainless steel (SUS304)
AL	Aluminum

Linearity According to Material

Characteristic Data, p. 148



To use the default linearity adjustment after changing materials, select the material and then perform **3** *Executing Adjustment*.

3

Executing Adjustment.

Changing to FUN Mode and LINER

1. Set the mode switch to FUN.



2. Use the LEFT or RIGHT Key to display LINER on the main display.

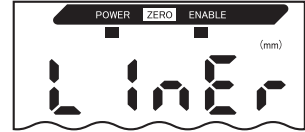

Setting Sensor Object Material

3. Press the ENT Key.
METAL will be displayed.

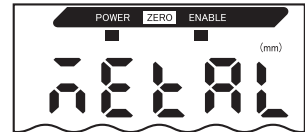

4. Press the UP or DOWN Key.
The sub-display will flash.



5. Use the UP or DOWN Key to select the material.



6. Press the ENT Key to confirm the selection.
The setting will be registered.



2 Entering Adjustment Values

Set the sensing object at the positions for 0%, 50%, and 100% of the rated measurement distance and register those measured values as the adjustment values.

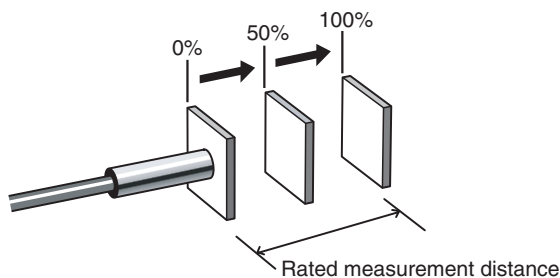

Measurement distance, p. 143

Perform the registration in order, starting with 0%, then 50% and 100% of the measurement distance.



To simply replace the sensing object material and use the default linearity adjustment, skip this operation and perform **3 Executing Adjustment**.

Entering Adjustment Value for 0% Position

1. Set the sensing object at the 0% position.

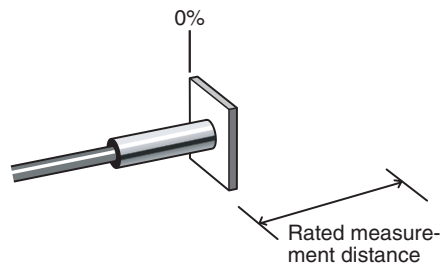

2. Use the LEFT and RIGHT Keys to display D000.

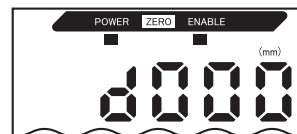

3. Press the ENT Key.

The sub-display will show OK and the adjustment value will be registered.



Press the ENT Key again to reinput the adjustment value.

Entering Adjustment Value for 50% Position

- 4.** Move the sensing object to the 50% position.

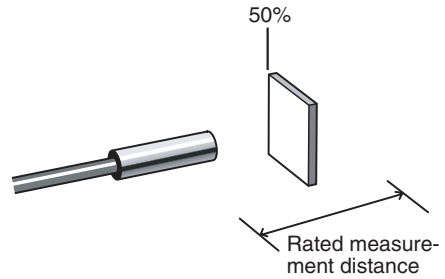

- 5.** Use the LEFT and RIGHT Keys to display D050.

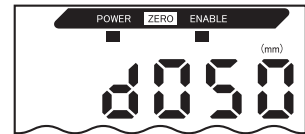

- 6.** Press the ENT Key.

The sub-display will show OK and the adjustment value will be registered.



Press the ENT Key again to reinput the adjustment value.

CHECK!

Entering Adjustment Value for 100% Position

- 7.** Move the sensing object to the 100% position.

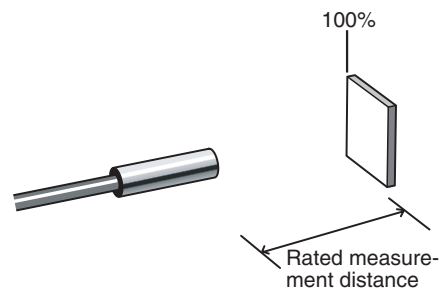

- 8.** Use the LEFT or RIGHT Keys to display D100.

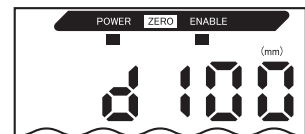

- 9.** Press the ENT Key.

The sub-display will show OK and the adjustment value will be registered.



Press the ENT Key again to reinput the adjustment value.

CHECK!

3 Executing Adjustment

This section describes how to execute adjustment based on the settings made in steps 1 and 2.

Executing Adjustment

1. Use the LEFT and RIGHT Keys to display TABLE on the main display and START on the sub-display.

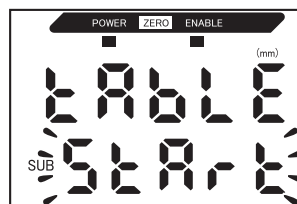

2. Press the ENT Key.



Linear adjustment will be executed.

When the adjustment data has been registered, the sub-display will show OK.

OK



If the sub-display shows ERRTB, there has been a mistake in the settings. Check the material selected for the sensing object and the set positions and register the settings again.

NG



■ Cancelling Adjustment

The adjustment settings will be cleared if the adjustment is cancelled.

1. Use the LEFT and RIGHT Keys to display TABLE on the main display and CANCL on the sub-display.

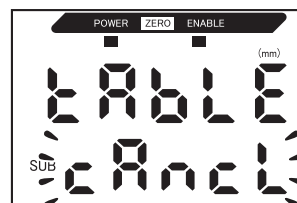

2. Press the ENT Key.



The settings for the current adjustment will be cancelled and the display will change to LINER.

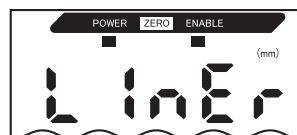

Initializing Adjustment Settings

Initialize the linearity adjustment settings to return to the default settings.

This section describes how to initialize the linearity adjustment settings only. To initialize other settings, use the INIT function.

 Initializing Settings Data, p. 133

Moving to FUN Mode and LINER

1. Set the mode switch to FUN.



2. Use the LEFT and RIGHT Keys to display LINER on the main display.

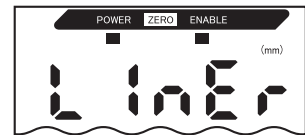

Initializing Settings

3. Press the ENT Key.

The display will show METAL.

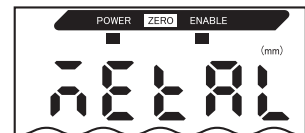

4. Use the LEFT and RIGHT Keys to display LINIT.

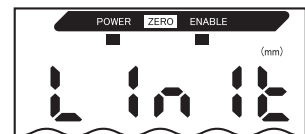

5. Press and hold down the ENT Key.

One dash (-) at a time will appear on the sub-display.

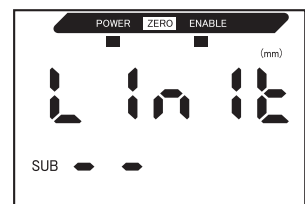





6. Release the ENT Key once OK is displayed on the sub-display.

The adjustment settings have been initialized.



Section 4

MAIN APPLICATIONS AND SETTING METHODS

 Detecting Bottom Deadpoint	62
 Measuring Height	67
 Measuring Eccentricity and Vibration	71
 Measuring Thickness	74

Detecting Bottom Deadpoint

This section describes, as an example, how to detect the bottom deadpoint of a press machine.

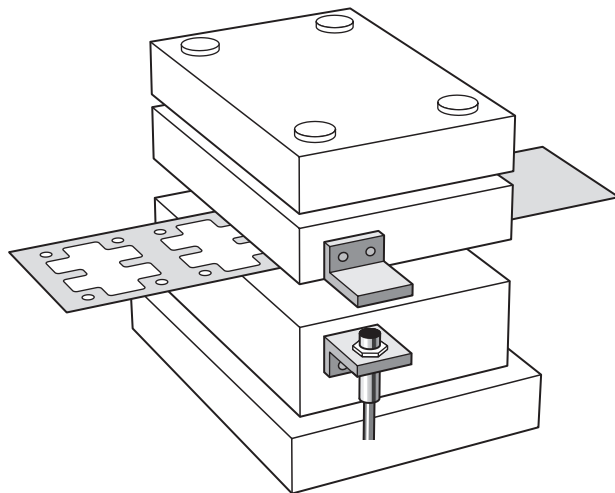

When making settings while still connected to an external device, set the Amplifier Unit's judgement output hold input to ON so that the output to the external device remains unchanged.

CHECK!



Adjust linearity before executing this operation.



Adjusting Linearity, p. 54

CHECK!

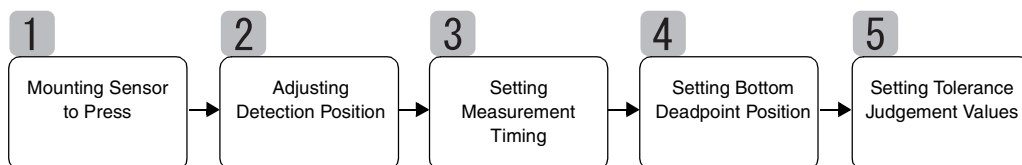

Flow of Operation



1 Mounting Sensor to Press

Mount the Sensor Head and the sensing object to the press machine. Refer to the following diagram for the required mounting jig.

 Installing Sensor Heads, p. 30

 Use a ferrous sensing object and one that is as large as or larger than the standard sensing object.
CHECK!  Sensing object, p. 143

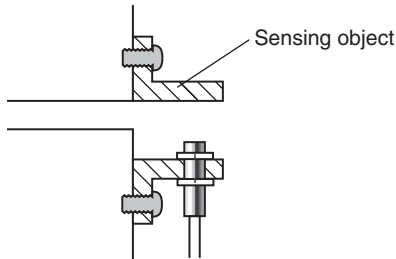

2 Adjusting Detection Position

Adjust the position of the Sensor Head so that when the press machine is set at the bottom deadpoint position, the distance between the Sensor Head and the sensing object is about half of the measurement distance. Refer to the Amplifier Unit display while adjusting the Sensor Head position.

 Measurement Distance, p. 143

Section 4 MAIN APPLICATIONS AND SETTING METHODS

1. Put the press machine in inching mode and lower the stripper (or top mold) to the bottom deadpoint.

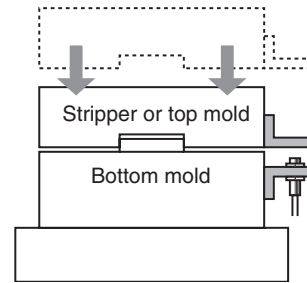

2. Adjust the position of the Sensor Head so that this position is at about half of the measurement distance.

The measured value will be displayed on the Amplifier Unit. Refer to this display while adjusting the Sensor Head.

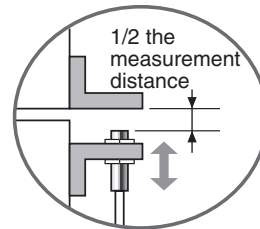

3 Setting Measurement Timing

The hold function is used to detect the bottom deadpoint.

To ignore bounding when measuring during press operation, specify a time delay from the timing signal to when sampling starts.



When the timing signal cannot be input from the device, set a self-down trigger.

CHECK!

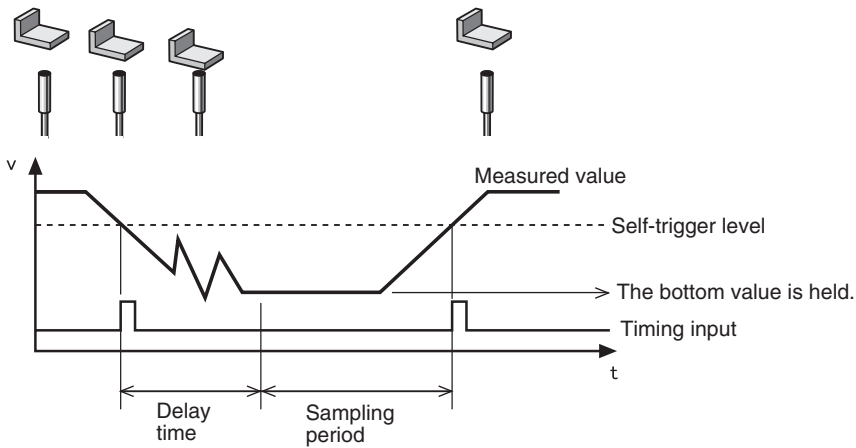

Refer to *Section 5 Detailed Settings* for details on settings.

Using Hold Functions, p. 81

4 Setting Bottom Deadpoint Position

Set the bottom deadpoint as reference value 0.

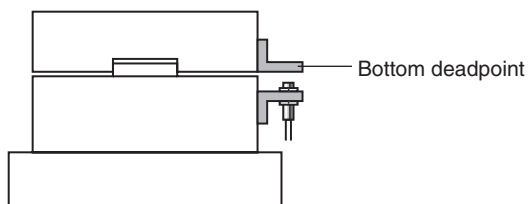

Refer to *Section 6 Auxiliary Functions* for details on settings.



Using the Zero Reset Function, p. 127



Set the previous value comparison to ignore slight bottom deadpoint fluctuation at press startup and the influence of temperature drift.

CHECK!



Comparing Measured Values (Previous Value Comparisons), p. 88



A value other than 0 can be set.

CHECK!



Setting Offset Values, p. 128

5 Setting Tolerance Judgement Values

Set the upper and lower limits (the HIGH and LOW threshold values) for the PASS (OK) range for the reference value set in step **4**.

Setting	Description
HIGH threshold	Enter the upper threshold for lift caused by scraps or residue.
LOW threshold	Enter the lower threshold for overshooting caused by pressing with no workpiece.

The HIGH, PASS, and LOW judgement results will be output based on the threshold values set here.

Measurement result	Judgement
Measurement result > HIGH threshold	HIGH
LOW threshold ≤ Measurement result ≤ HIGH threshold	PASS
LOW threshold > Measurement result	LOW

Refer to *Section 5 Detailed Settings* for details on operation.



Entering Threshold Values, p. 97

Measuring Height

This section describes how to measure the height of an object, using a rivet as an example.

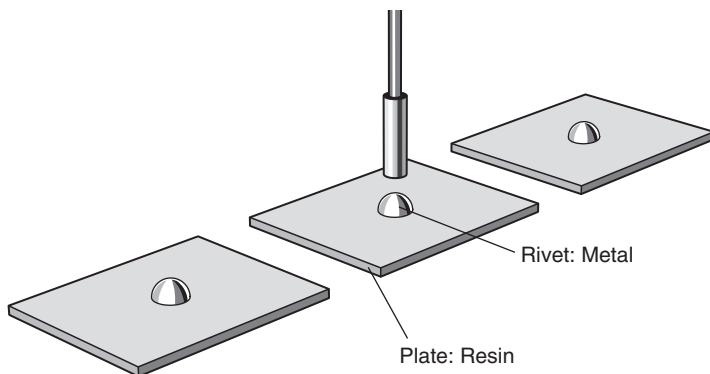

When making settings while still connected to an external device, set the Amplifier Unit's judgement output hold input to ON so that the output to the external device remains unchanged.



Adjust linearity before performing measurement.



Adjusting Linearity, p. 54

Flow of Operation

Place an actual sensing object in position. Have a reference sample ready beforehand.

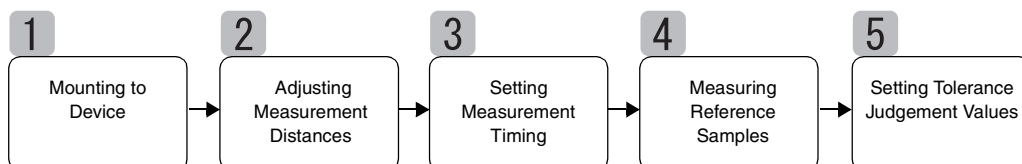

1 Mounting to Device

Mount the Sensor Head to the inspection device.

Refer to the following diagram and prepare a mounting jig.

 Installing Sensor Heads, p. 30

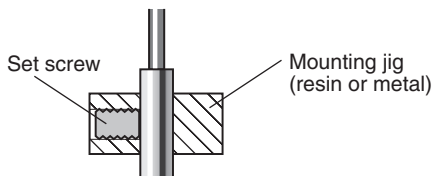

2 Adjusting Measurement Distances

Place the reference sample in position and adjust the Sensor Head position. Refer to the Amplifier Unit display and adjust the Sensor Head position so that the upper and lower limits of the height (H) to be measured fall within the measurement distance.

 Measurement distance, p. 143

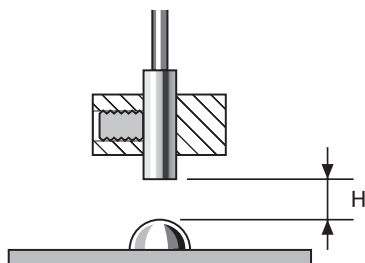

 **Measured Value Display**
The Amplifier Unit display shows the distance (H) from the reference sample (default).
The display can also be set to show the height of the reference sample.

CHECK!

 Changing Display Scales, p. 90

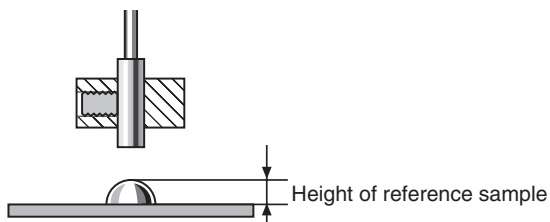

3 Setting Measurement Timing

The hold function is used for height measurement. The minimum value (bottom) during the sampling period is held.



When the timing signal cannot be input from the device, set a self-down trigger.

CHECK!

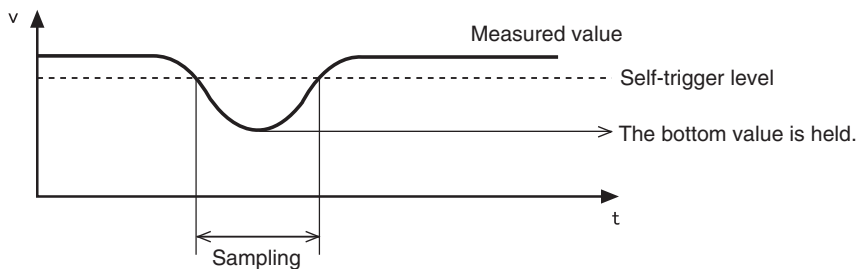

The following settings are required when the reference sample height is displayed using the scaling function:

Measurement trigger: Self-up trigger

CHECK! Hold condition: Peak hold

Refer to *Section 5 Detailed Settings* for details on settings.



Using Hold Functions, p. 81

4 Measuring Reference Samples

The height of the reference sample is measured using position teaching and the measurement result is registered as the HIGH threshold value.

The registered value becomes the reference for the threshold value set in step 5.

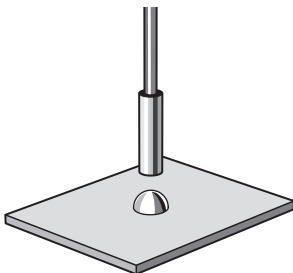

Refer to *Section 5 Detailed Settings* for details on settings.



Position Teaching, p. 99



The reference sample height can also be set to 0.



Using the Zero Reset Function, p. 127

CHECK!

5 Setting Tolerance Judgement Values

Refer to the HIGH threshold registered in step 4 and set the upper and lower limits (HIGH and LOW thresholds) for a PASS (OK) judgement.

The HIGH, PASS, and LOW judgement results will be output based on the threshold values set here.

Measurement result	Judgement
Measurement result > HIGH threshold	HIGH
LOW threshold ≤ measurement result ≤ HIGH threshold	PASS
LOW threshold > measurement result	LOW

Refer to *Section 5 Detailed Settings* for details on operation.



Inputting Threshold Values Directly, p. 98

Measuring Eccentricity and Vibration

This section describes, as an example, how to measure the eccentricity of a shaft.

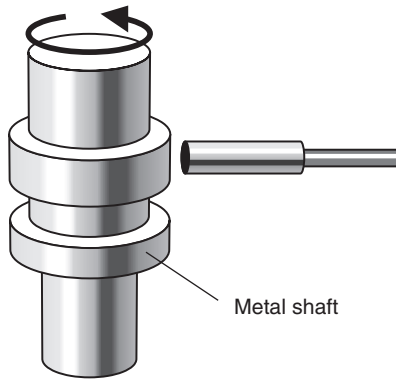

When making settings while still connected to an external device, set the Amplifier Unit's judgement output hold input to ON so that the output to the external device remains unchanged.



Adjust linearity before performing this operation.



Adjusting Linearity, p. 54

■ Flow of Operation

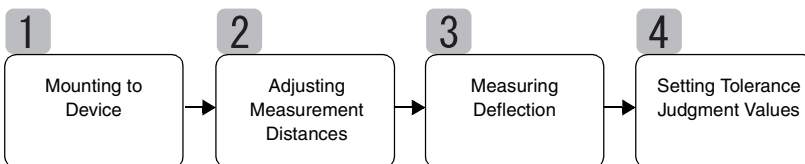

1 Mounting to Device

Mount the Sensor Head to the inspection device.

Refer to the following diagram and prepare a mounting jig.

 Installing Sensor Heads, p. 30

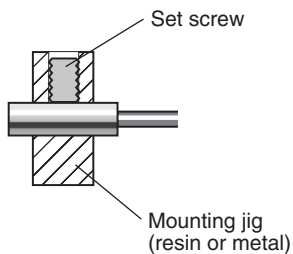

2 Adjusting Measurement Distances

Adjust the position of the Sensor Head so that the distance (H) between the Sensor Head and the sensing object is about half the measurement distance, as shown in the diagram. Refer to the Amplifier Unit display while adjusting the Sensor Head position.

 Measurement distance, p. 143

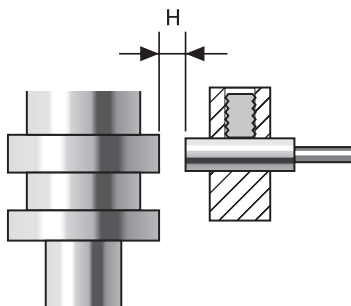

3 Measuring Deflection

Use the peak-to-peak hold function to measure the normal deflection. Rotate the shaft, input a timing signal from an external device, and measure the deflection. The difference between the maximum and minimum measurement results (the deflection) will be used as a reference when setting tolerances.

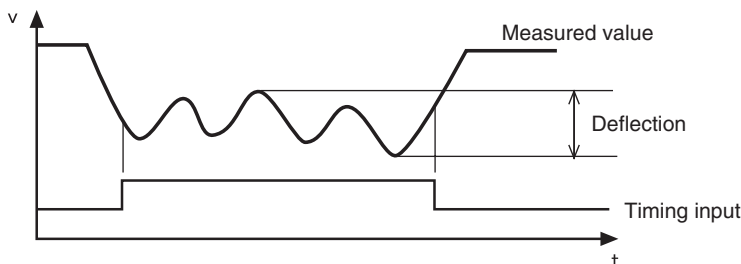

Refer to *Section 5 Detailed Settings* for details on settings.

Using Hold Functions, p. 81

4 Setting Tolerance Judgment Values

Refer to the deflection measured in step **3** and set either the upper limit (HIGH threshold) or lower limit (LOW threshold) for a PASS (OK) judgement.

The judgement result will be output based on the threshold value set here. The output will depend on the type of threshold set.

Output when upper limit is set: PASS or HIGH

Output when lower limit is set: PASS or LOW

Measurement result	Judgement
Measurement result > HIGH threshold	HIGH
LOW threshold ≤ Measurement result ≤ HIGH threshold	PASS
LOW threshold > Measurement result	LOW

Refer to *Section 5 Detailed Settings* for details on settings.

Inputting Threshold Values Directly, p. 98

Measuring Thickness

This section describes how to measure thickness, using the thickness of a steel plate as an example.

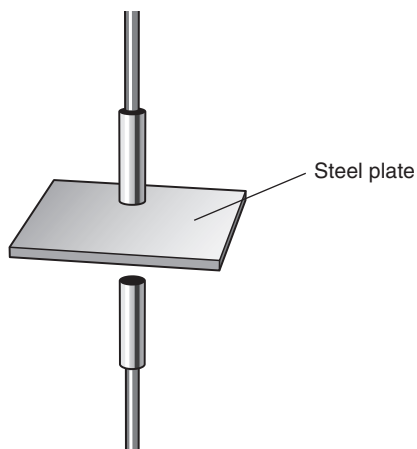

When making settings while still connected to an external device, set the Amplifier Unit's judgement output hold input to ON so that the output to the external device remains unchanged.



Adjust linearity before performing this operation.



Adjusting Linearity, p. 54

■ Flow of Operation

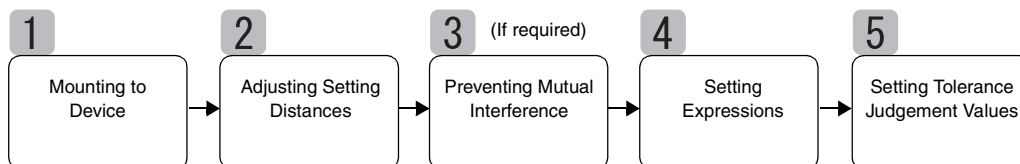

1 Mounting to Device

■ Connecting Amplifier Units

Connect two Amplifier Units by placing a Calculating Unit between them as shown in the diagram.

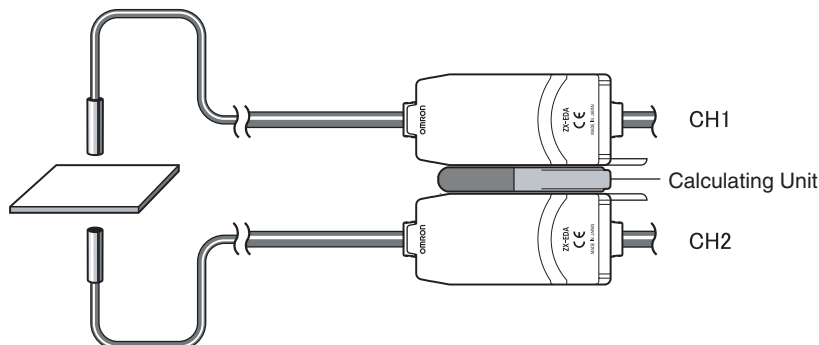

The calculation result is displayed on (i.e., output to) the CH2 Amplifier Unit. Connect the CH2 output cable to the external device to enable external control.

 Connections, p. 34



CHECK!

The CH1 Amplifier Unit will display (output) the measurement result for the CH1 Sensor Head only.

■ Mounting Sensor Heads to Inspection Device

Refer to the following diagram and prepare mounting jigs. Mount the Sensor Heads facing each other.

 Installing Sensor Heads, p. 30

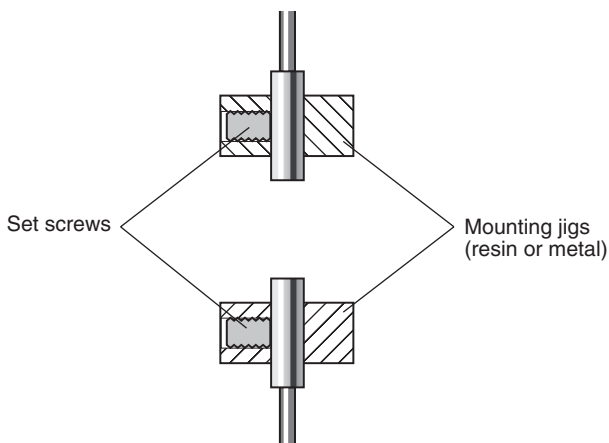

2 Adjusting Setting Distances

Set a reference sample with a known thickness (T).

Adjust the Sensor Heads so that the distances between the reference sample and the Sensor Heads (A and B) are each about half the measurement distance. Refer to the Amplifier Unit display when adjusting the Sensor Heads.

 Measurement distance, p. 143

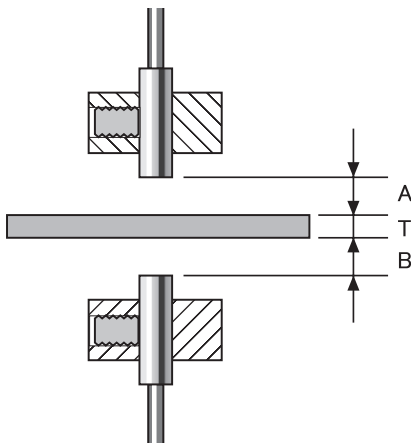

3 Preventing Mutual Interference

Mutual interference prevention settings are required when the distance between Sensor Heads is less than the mutual interference distance.

These settings are not required if the Sensor Heads are further apart than the mutual interference distance.

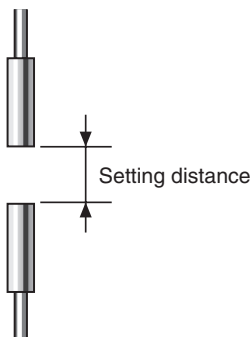

 For information on mutual interference distance, refer to *Mutual Interference*, p. 32.

The settings are made on the CH1 Amplifier Unit. Refer to *Section 6 Auxiliary Functions* for details on settings.

 Preventing Mutual Interference between Sensors, p. 120

4 Setting Expressions

Position the reference sample and set the expression to calculate the thickness of the reference sample.

The settings are made on the CH2 Amplifier Unit. Select THICK as the expression type and enter the thickness (T) of the reference sample.

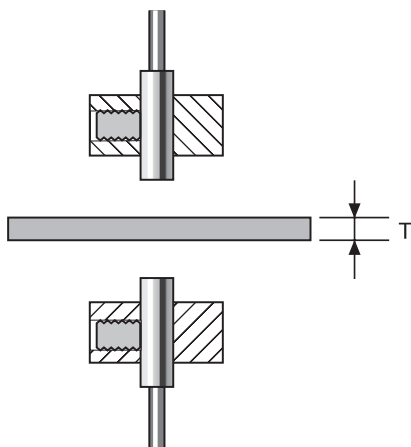

When the thickness is entered, the positional relationship between the Sensor Heads at that point will be registered. The thickness is measured based on the positional relationship of the Sensor Heads.

Refer to *Section 6 Auxiliary Functions* for details on settings.



Performing Calculations, p. 116

5 Setting Tolerance Judgement Values

Set the upper and lower limits (HIGH and LOW thresholds) for the thickness for a PASS (OK) judgement.

The HIGH, PASS, and LOW judgement results will be output based on the threshold values set here.

Measurement result	Judgement
Measurement result > HIGH threshold	HIGH
LOW threshold ≤ measurement result ≤ HIGH threshold	PASS
LOW threshold > Measurement result	LOW

Refer to *Section 5 Detailed Settings* for details operations.



Inputting Threshold Values Directly, p. 98

Section 5

DETAILED SETTINGS

☒	Setting Number of Samples to Average	80
☒	Using Hold Functions	81
☒	Comparing Measured Values (Previous Value Comparisons)	88
☒	Changing Display Scales	90
☒	Entering Threshold Values	97
☒	Linear Output	103
☒	Setting Judgement Output Timing (Timer)	112

Setting Number of Samples to Average

The number of samples to average is the number of data points used to average data measured by the Sensor. The average value will be output.

Use the number of samples to average function to ignore sudden variations in measured values. If the number of samples is increased, however, the response time of the judgement outputs and linear output will be increased.

Selection for No. of samples to average	Response time
1	0.3 ms
2	0.5 ms
4	0.8 ms
8	1.5 ms
16	2.5 ms
32	5 ms
64 (default)	10 ms
128	20 ms
256	40 ms
512	75 ms
1024	150 ms
2048	300 ms
4096	600 ms

Moving to FUN mode and AVE

1. Set the mode switch to FUN.



2. Use the LEFT and RIGHT Keys to display AVE on the main display.

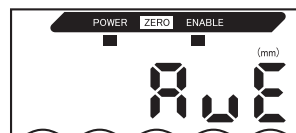

Selecting Number of Samples to Average

3. Press the UP or DOWN Key. The sub-display will flash.
4. Use the UP and DOWN Keys to select the number of samples to average.
5. Press the ENT Key to confirm the selection. The setting will be registered.



Using Hold Functions

The hold functions hold data for specific points during the measurement period, such as the maximum or minimum value, and output those values at the end of the measurement period.

■ Flow of Operation

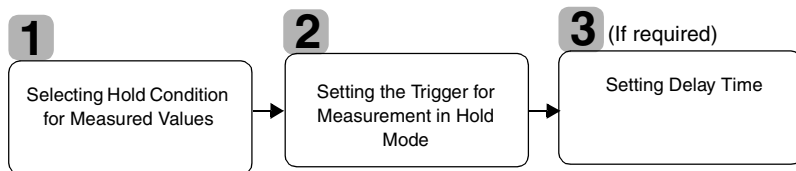

1 Selecting Hold Condition for Measured Values

The time period from the start of hold measurements to the end of hold measurements is called the sampling period.

The value to be held during that sampling period is selected here.



The CLAMP value is output until the first sampling period is finished.
CLAMP value, p. 110



Any of the 5 settings shown in the table can be selected as the value to hold.

Selection	Details
OFF (Default)	Hold measurement is not performed. The measured value is always output.
P-H (Peak hold)	Holds the maximum value during the sampling period. The output changes when the sampling period is finished and is held then until the end of the next sampling period.
B-H (Bottom hold)	Holds the minimum value during the sampling period. The output changes at the end of the sampling period and is held until the end of the next sampling period.

Section 5 DETAILED SETTINGS

Selection	Details
PP-H (Peak-to-peak hold)	<p>Holds the difference between the maximum and minimum values. This option is selected mainly when detecting vibration. The output changes at the end of the sampling period and is held until the end of the next sampling period.</p>
S-H (Sample hold)	<p>Holds the measured value at the start of the sampling period. The output changes at the start of the sampling period and is held until the start of the next sampling period.</p>
AVE-H (Average hold)	<p>Holds the average measured value during the sampling period. The output changes at the end of the sampling period and is held until the end of the next sampling period.</p>

Moving to FUN mode and HOLD

1. Set the mode switch to FUN.



2. Use the LEFT and RIGHT Keys to display HOLD on the main display.

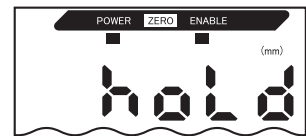

Selecting Hold Condition

3. Press the UP or DOWN Key.

The sub-display will flash.



4. Use the UP and DOWN Keys to select the hold condition.



5. Press the ENT Key to confirm the selection.

The setting will be registered.



2 Setting the Trigger for Measurement in Hold Mode

Select the input method for the timing of the start and end of the measurement period.

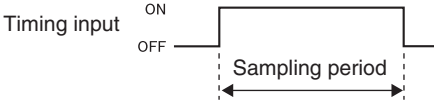
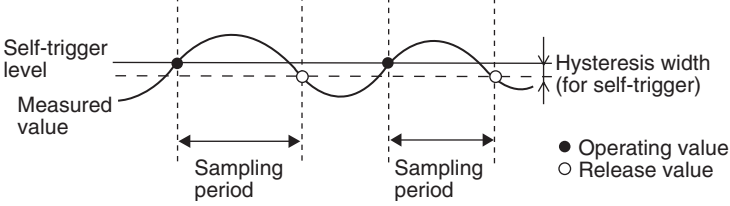
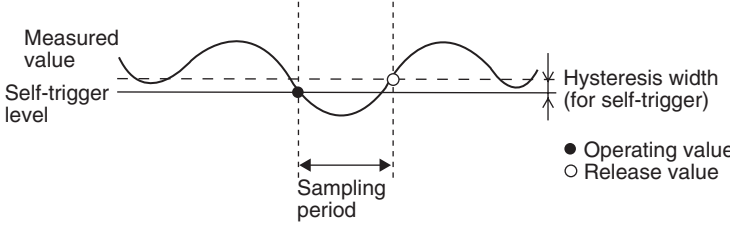
Selection	Details
<p>TIMIG (Timing input)</p> <p>(Default)</p>	<p>Enter the trigger for the start of sampling by using the timing input. The period that the timing signal is ON is the sampling period.</p>  <p>Timing input ON OFF Sampling period</p> <p>When a delay time is set, the input OFF timing and the end of the sampling period will not be synchronous. Sampling will end after the specified sampling period has expired.</p> <p>CHECK!</p>
<p>UP (Self-up trigger)</p>	<p>The sampling period is the period that the measured value is greater than the specified self-trigger level. Hold measurement is possible without a sync input.</p>  <p>Self-trigger level Measured value Sampling period Hysteresis width (for self-trigger)</p> <p>● Operating value ○ Release value</p> <p>When a delay time is set, the timing when the measured value becomes smaller than the self-trigger level and the end of the sampling period will not be synchronous. Sampling will end after the specified sampling period has expired.</p> <p>CHECK!</p>
<p>DOWN (Self-down trigger)</p>	<p>The sampling period is the period that the measured value is lower than the specified self-trigger level. Hold measurement is possible without a sync input.</p>  <p>Measured value Self-trigger level Sampling period Hysteresis width (for self-trigger)</p> <p>● Operating value ○ Release value</p> <p>When a delay time is set, the timing when the measured value becomes greater than the self-trigger level and the end of the sampling period will not be synchronous.</p> <p>CHECK!</p>

 **Hysteresis (hysteresis width)**
Set the hysteresis based on the fluctuations in the measured values around the trigger level. The hysteresis will be applied from the start of the sampling period and will prevent timing input chattering.

Selecting Trigger Types

1. Use the LEFT and RIGHT Keys to display H-TRG on the main display.
H-TRG will not be displayed if the hold condition is set to OFF.

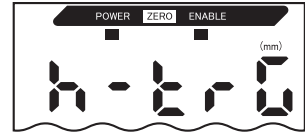

2. Press the UP or DOWN Key.
The sub-display will flash.



3. Use the UP or DOWN Key to select the trigger type.



4. Press the ENT Key to confirm the selection.
The selected trigger type will be registered.



Setting Trigger Levels (when UP or DOWN Is Selected)

5. Use the RIGHT or LEFT Key to display H-LVL on the main display.
H-LVL will not be displayed if timing input (TIMIG) is selected as the trigger.

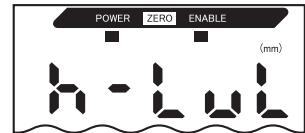

6. Press the UP or DOWN Key.
The leftmost digit of the sub-display will flash.



7. Use the Cursor Keys to set the trigger level.



----- Move between digits.



----- Increment and decrement the numeric value.

8. Press the ENT Key to confirm the settings.
The trigger level will be registered.



Setting Hysteresis Width (when UP or DOWN Is Selected)

9. Use the LEFT and RIGHT Keys to display H-HYS on the main display.
H-HYS will not be displayed if timing input (TIMIG) is set as the trigger.

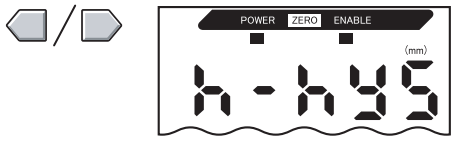

10. Press the UP or DOWN Key.
The leftmost digit of the sub-display will flash.



11. Use the Cursor Keys to set the hysteresis width for the trigger level.

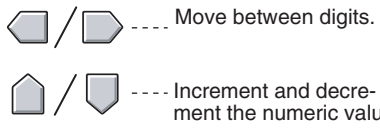

12. Press the ENT Key to confirm the setting.
The hysteresis width will be registered.



3 Setting Delay Time

Delay time is set to ignore measurements immediately after the timing input. This is useful for avoiding bounding during device startup and the influence of machine vibration.

The delay time (the delay between timing input and the start of sampling) and the sampling period can be set.

The default delay time setting is OFF.



Make the sum of the delay time and sampling period less than the timing input ON interval. If the next timing input for measurement is received before the delay and sampling period have passed, that timing input will be ignored and will not be reflected in the sampling.

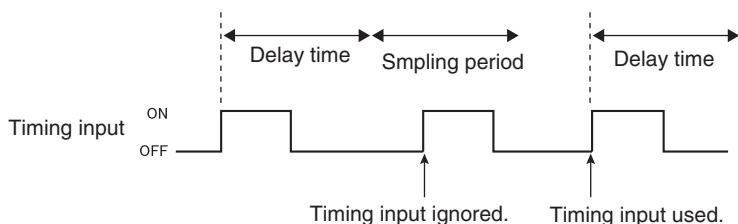

Moving to Delay Hold (H-DLY)

1. Use the LEFT and RIGHT Keys to display H-DLY on the main display.

H-DLY will not be displayed if the delay conditions are set to OFF.

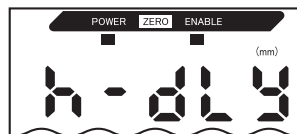

2. Press the UP or DOWN Key.

The sub-display will flash.



3. Use the UP and DOWN Keys to display ON.



4. Press the ENT Key.

The settings mode for the H-DLY function is now enabled.



Setting Delay Time

- 5.** Use the LEFT and RIGHT Keys to display H-D-T on the main display.
H-D-T will not be displayed if the H-DLY function is set to OFF.

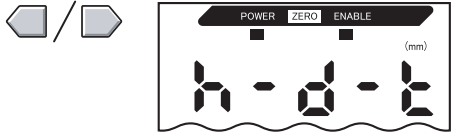

- 6.** Press the UP or DOWN Key.
The leftmost digit of the sub-display will flash.



- 7.** Enter the delay time (ms).

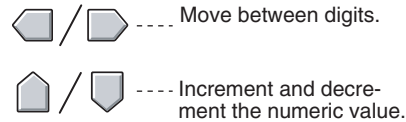

- 8.** Press the ENT Key to confirm the setting.
The delay time will be registered.



Setting Sampling Period

- 9.** Use the LEFT and RIGHT Keys to display H-S-T on the main display.
H-S-T will not be displayed if the H-DLY function is set to OFF.

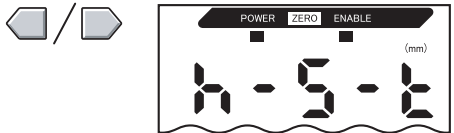

- 10.** Press the UP or DOWN Key.
The leftmost digit of the sub-display will flash.



- 11.** Use the Cursor Keys to enter the sampling period (ms).

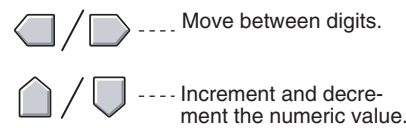

- 12.** Press the ENT Key to confirm the setting.
The sampling period will be registered.



Comparing Measured Values (Previous Value Comparisons)

Use the previous value comparison function to ignore gradual changes in measured values over time, due to factors such as temperature drift, and only detect and judge sudden changes.

The hold function must be set before previous value comparison can be set. The difference from the previous hold value with a PASS judgement becomes the measured value. For example, if the judgement for that previous measurement is HIGH or LOW, the comparison is performed with the hold value before that.

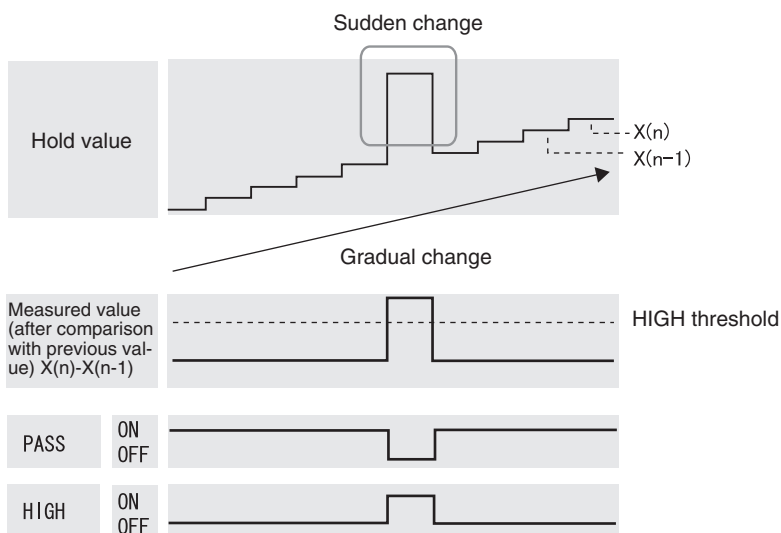

The hysteresis width setting will be disabled if the previous value comparison function is used.

Hysteresis Setting, p. 102

Moving to FUN mode and SPCL

1. Set the mode switch to FUN.



2. Use the LEFT and RIGHT Keys to display SPCL on the main display.

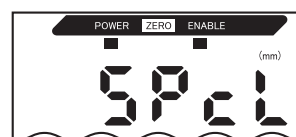

Moving to COMP

- 3.** Press the UP or DOWN Key.

The sub-display will flash.



- 4.** Use the UP and DOWN Keys to display SET or ALL.



- 5.** Press the ENT Key.



- 6.** Use the LEFT and RIGHT Keys to display COMP on the main display.

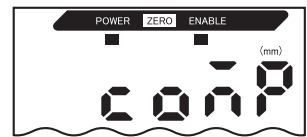

Setting Previous Value Comparison

- 7.** Press the UP or DOWN Key.

The sub-display will flash.



- 8.** Use the UP and DOWN Keys to display ON.



- 9.** Press the ENT Key to confirm the setting.

The previous value comparison function can now be used.

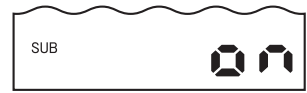

Changing Display Scales

Change the display scale when you want to display a value different on the main display to the actual measured value.





Place the sensing object in position and make the settings for either one-point or two-point scaling.



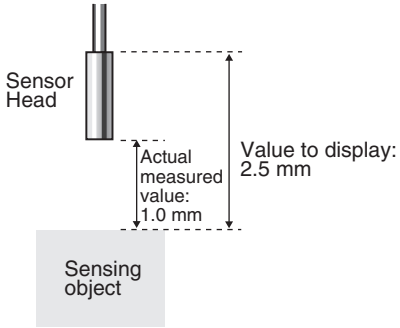
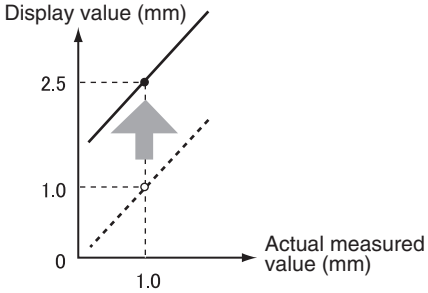

CHECK!

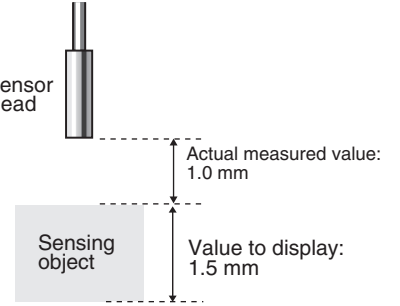
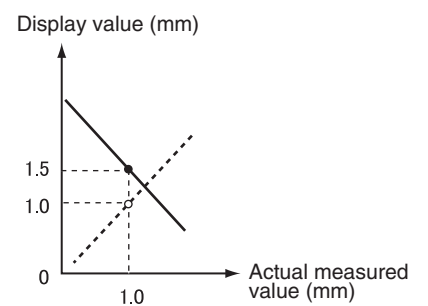
The scaling set here is reflected in the display only. The output does not change.
The minimum display value is -19,999 and the maximum is 59,999. If the measurement result is less than the minimum display value after scaling is executed, the display will be -19,999. If the measurement result is greater than the maximum, the display value will be 59,999.

Scaling Application Example

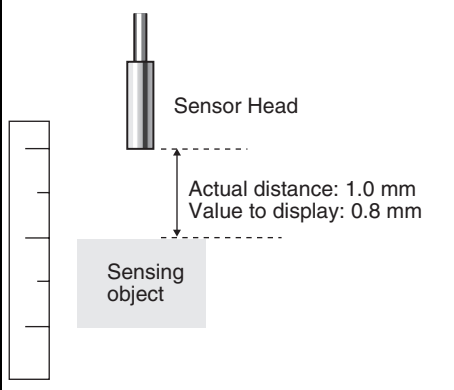
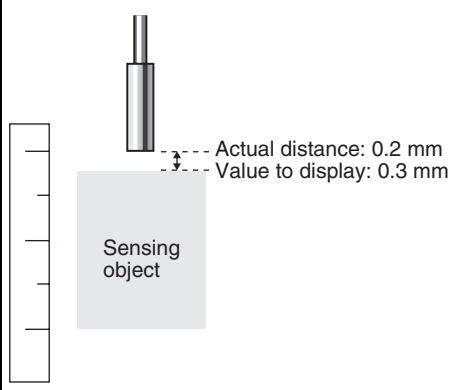
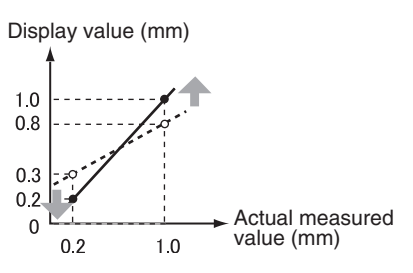
Purpose	Settings Method	
<p>To display distance from Sensor Head</p> 	<p>Offset the display value.</p> 	<p>One-point scaling with no inverted display values</p> <p> p. 92</p>
<p>To display the height of the sensing object</p> 	<p>Offset the display value and invert the relationship between display and reference values.</p> 	<p>One-point scaling with inverted display values</p> <p> p. 92</p>

Purpose	Settings Method	
<p>To correct display values to match actual distances</p>  <p>Sensor Head</p> <p>Actual distance: 1.0 mm Value to display: 0.8 mm</p> <p>Sensing object</p> <p>Slide gauge</p>  <p>Actual distance: 0.2 mm Value to display: 0.3 mm</p> <p>Sensing object</p>	<p>Offset the display value and change the display value range.</p> 	<p>Two-point scaling</p> <p> p. 95</p>



The settings listed below return to the default settings when scaling is set. Make the settings for these items after scaling settings have been completed.

CHECK!

-  Self-trigger level, p. 83
- Output Settings (Monitor Focus), p. 103
- Using the Zero Reset Function, p. 127
- Finding Thicknesses, p. 118

One-point Scaling

With one-point scaling, measurement is performed for one position and an offset value is set for that measurement. Both offset and display inversions (changing the relationship between increasing and decreasing values) can be set.

This section describes how to make settings for one-point scaling, using an different example.

Example: Displaying the Height of the Sensing Object

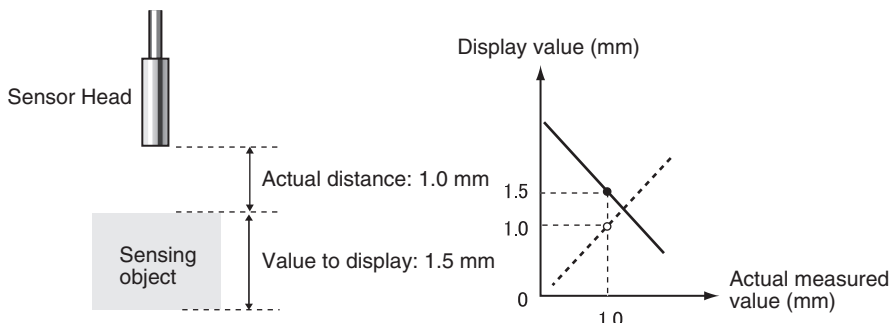

Moving to FUN mode and SPCL

1. Set the mode switch to FUN.



2. Use the LEFT and RIGHT Keys to display SPCL on the main display.

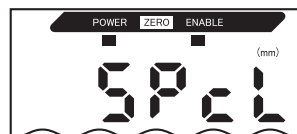

Moving to SCALE

3. Press the UP or DOWN Key.

The sub-display will flash.



4. Use the UP and DOWN Keys to display SET or ALL.



5. Press the ENT Key.



6. Use the LEFT and RIGHT Keys to display SCALE on the main display.

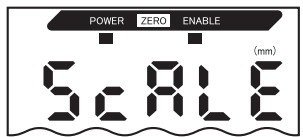

Executing Scaling

7. Press the UP or DOWN Key.
The sub-display will flash.



8. Use the UP and DOWN Keys to display ON.



9. Press the ENT Key to confirm the setting.
The sub-display will show P1SCL.

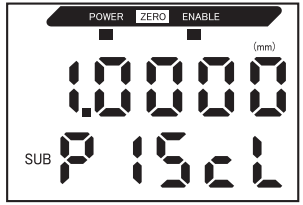

10. Set the sensing object at the position where the display value change is required.



Set the sensing object within the measurement distance. The ENABLE indicator will be lit when the sensing object is within the measurement distance. Scaling is not possible if the sensing object is not within the distance.

11. Press one of the Cursor Keys.
The current measured value will be displayed on the main display.
The leftmost digit of the sub-display will flash.

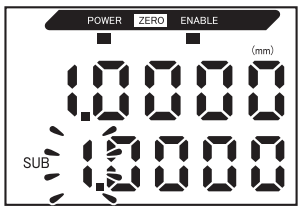

12. Use the Cursor Keys to set the offset for the measured value on the sub-display.
The position of the decimal point can be changed using the next steps.



---- Move between digits.



---- Increment and decrement the numeric value.

13. Press the ENT Key to confirm the settings.
The decimal point will flash.



14. Use the LEFT and RIGHT Keys to change the position of the decimal point, if necessary.



Section 5 DETAILED SETTINGS

15. Press the ENT Key to confirm the settings.

The inverted display settings will appear on the sub-display.



Selecting Inverted Display

16. Use the UP and DOWN Keys to inverted displays.



Options	Details
D-FWD	Not inverted.
D-INV	Inverted (Inverts the increase/decrease relationship between display and measured values)

17. Press the ENT Key to confirm settings.

The sub-display will be P2SCL.



18. Press the ENT Key.



Confirming that Scaling Is Completed

If scaling has been completed correctly, the display will be OK.

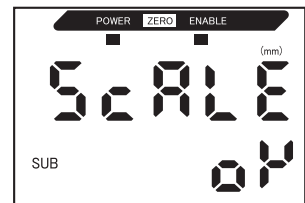

If scaling was unable to be completed, the display will be NG.

Check that the sensing object is within the measurement distance and execute scaling again.

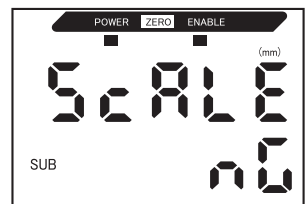

Two-point Scaling

Measurement is performed at two positions and offset values are set for those measurements. Both an overall offset can be set and the range can be changed.

This section describes how to set two-point scaling, using an example of correcting display values to match actual distances.

Example: Correcting Display Values to Match Actual Distances

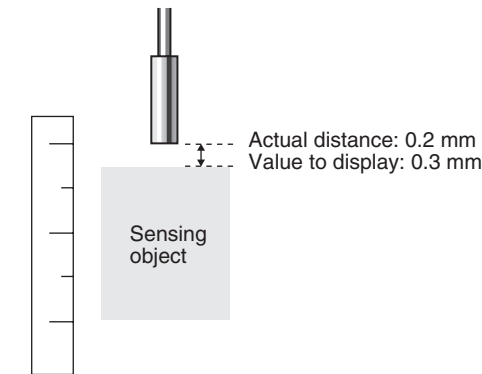
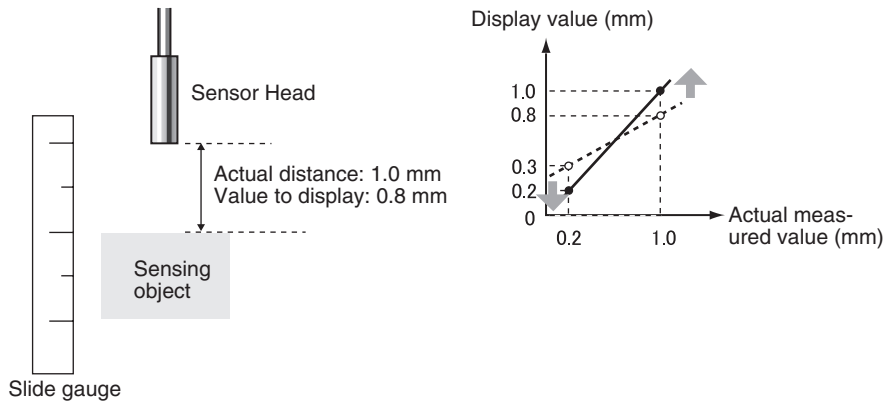

Separate the two specified points by at least 1% of the rated measurement distance for the connected Sensor.

CHECK! For example, the rated measurement distance for the ZX-ED01T Sensor is 1 mm. Therefore, the two specified points must be separated by 10 μm min.

Setting the First Point

1. Set the first point by following steps 1. to 15. of the one-point scaling procedure.

 p. 92



The range for two-point scaling is automatically set based on the values entered for the two points. Inverted display settings are ignored.

CHECK!

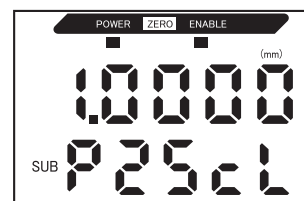

Section 5 DETAILED SETTINGS

Setting the Second Point

- Place the sensing object in the position for which the display is to be changed (the second point).



CHECK!

The sensing object must be set at a distance at least 1% of the rated measurement distance away from the first point and also at a distance within the measurement distance range.

- Press one of the Cursor Keys.

The current measured value will be displayed on the main display. The leftmost digit of the sub-display will flash.

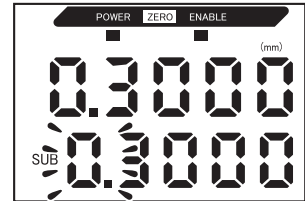
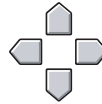

- Use the Cursor Keys to set the offset for the measured value.

The position of the decimal point can be changed using the next steps.



---- Move between digits.



---- Increment and decrement the numeric value.

- Press the ENT Key to confirm the settings.

The decimal point will flash.



- Use the LEFT and RIGHT Keys to move the decimal point.



- Press the ENT Key to confirm this setting.



Confirming the Completion of the Scaling Settings

If scaling has been completed correctly, the display will be OK.

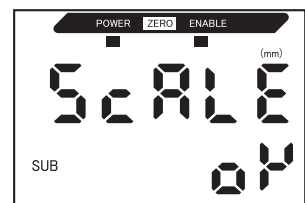

If scaling was unable to be completed, the display will be NG. Check the following points and then execute scaling again.

- Is the sensing object within the measurement distance?
- Are the two points separated by at least 1% of the rated measurement distance?

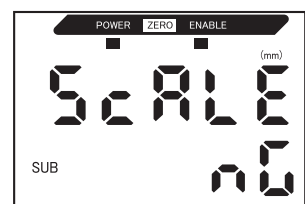

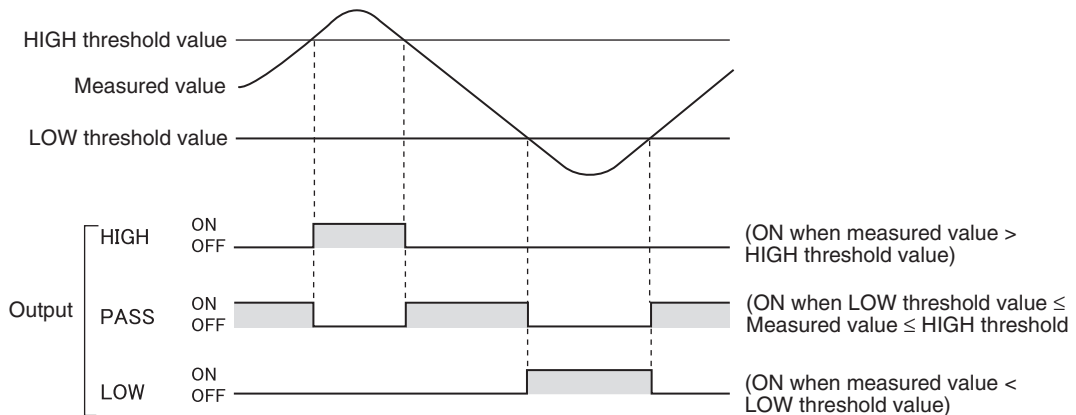

Entering Threshold Values

Threshold values are set to determine the range for PASS judgements. Both HIGH and LOW threshold values are set. There are three judgement outputs: HIGH, PASS, and LOW.



The following table outlines the three methods for setting the threshold values.

Method	Details
Direct input	Sets threshold values by direct numerical value input. Direct input is useful when you know the dimensions for an OK judgement or when you want to fine-tune threshold values after teaching.
Position teaching	Performs measurement and uses the measurement results to set threshold values. Position teaching is useful when threshold samples, i.e., with the upper and lower limits, can be obtained beforehand.
Automatic teaching	Performs measurement continuously while the keys are held down and sets the maximum and minimum measurements during that period as the threshold values. Automatic teaching is useful when you want to set threshold values by starting the device and obtaining real measurements.

 Hysteresis (hysteresis width) can also be set for threshold values. Set hysteresis when judgements are unstable to prevent chattering.
 p. 102
CHECK!

 When making settings while still connected to an external device, set the Amplifier Unit judgement's output hold input to ON so that the output to the external device remains unchanged. The judgement outputs in T mode will be the same as in RUN mode, i.e., HIGH, PASS, and LOW.
CHECK!

Inputting Threshold Values Directly

The threshold values can be set by directly inputting the numeric values.

Direct input is useful when the dimensions for an OK judgement are known beforehand or when fine-tuning threshold values after teaching.

Moving to T Mode

1. Set the mode switch to T.



Setting Threshold Values

2. Move the threshold switch to either H or L, i.e., the threshold to be set.



The current measured value is shown on the main display and the threshold being set (value for the threshold switch selection) will be displayed on the sub-display.

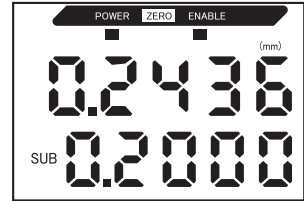

3. Press one of the Cursor Keys.

The leftmost digit of the threshold value will flash on the sub-display.

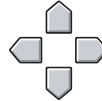

4. Use the Cursor Keys to set the threshold value.



--- Move between digits.



--- Increment and decrement the numeric value.

5. Press the ENT Key to confirm the settings.

The threshold values will be registered.



Countermeasures for Setting Errors

One of the following two errors has occurred if the display reads ERRHL or ERRHL.

HIGH threshold value < LOW threshold value

HIGH threshold value – LOW threshold value < hysteresis width



Hysteresis Setting, p. 102



If an error is displayed, the threshold value has not been updated. Set the threshold values again.

Position Teaching

When teaching is executed, measurement is performed and the measured values are set as the threshold values.

Position teaching is useful when threshold samples, i.e., with the upper and lower limits, can be obtained beforehand.

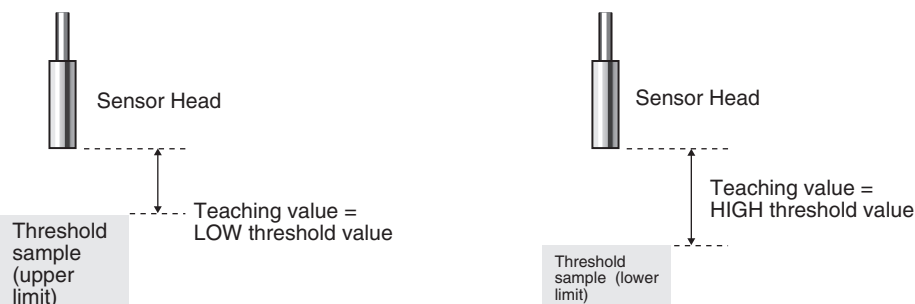

CHECK!

Hold, trigger mode, and scaling settings that have been made before teaching are reflected in the teaching measurements.

Moving to T Mode

1. Set the mode switch to T.



Setting Threshold Values

2. Move the threshold switch to either H or L, i.e., the threshold to be set.



The current measured value is shown on the main display and the threshold being set (the value for the threshold switch selection) will be displayed on the sub-display.

3. Place the threshold sample in position.

The main display value changes.

4. Press the ENT Key for at least one second and then release.



The measured value at the point that the ENT Key is released will be set as the threshold value. This threshold value will be shown on the sub-display.

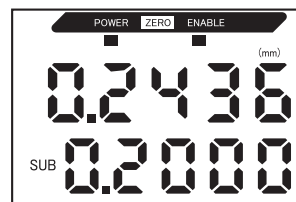

When ERR LH or ERR HL is displayed: p. 98



CHECK!

The threshold values set using position teaching can be changed using direct input. This is useful when setting judgement tolerances for measured values.



p. 98

Automatic Teaching

When automatic teaching is executed, measurement is performed while the keys are held down and the maximum and minimum measurements during that period are set as the threshold values.

Automatic teaching is useful when you want to set threshold values by starting the device and obtaining real measurements.

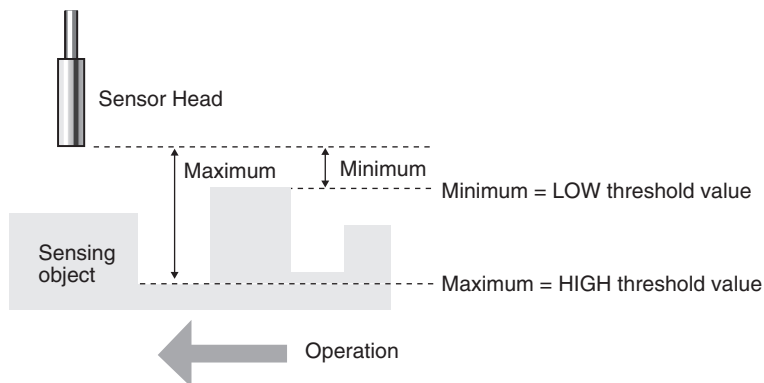

Hold, trigger mode, and scaling settings that have been made before teaching are reflected in the teaching measurements.

Moving to T Mode

1. Set the mode switch to T.



2. Start the device.



The threshold switch can be set to either position. Both HIGH and LOW thresholds will be set, regardless of the switch setting.

Setting Threshold Values

3. Start measurement.

Measurement will continue while the ENT and RIGHT Keys are held down.
AUTOT will flash on the sub-display after the keys have been pressed for one second.

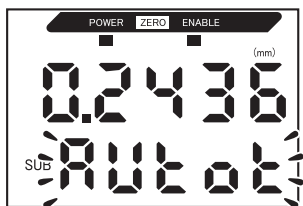

4. Release the ENT and RIGHT Keys to end measurement.

The maximum measured value during the measurement period will be set as the HIGH threshold value and the minimum will be set as the LOW threshold value.

The new threshold value (either HIGH or LOW, depending on the threshold switch setting) will be displayed on the sub-display.



If ERRLH is displayed: p. 98

CHECK! The threshold values set using automatic teaching can be changed using direct input. This is useful when setting judgement tolerances for measured values.
 p. 98

Hysteresis Setting

Set the hysteresis width for the upper and lower limits of judgements when the HIGH, PASS, or LOW judgements are unstable near the threshold values.

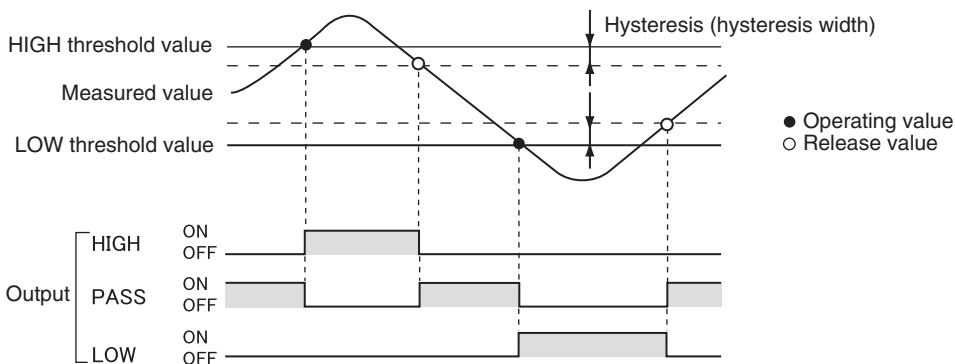

Hysteresis width settings are disabled when previous value comparison is used.



p. 80

CHECK!

To prevent self-trigger chattering, set hysteresis for the self-trigger.



p. 83

Moving to FUN Mode and HYS

1. Set the mode switch to FUN.
2. The main display will show HYS.
3. Press the UP or DOWN Key.
The leftmost of the sub-display will flash.
4. Use the Cursor Keys to enter the hysteresis width.
5. Press the ENT Key to confirm the setting.
The hysteresis width will be registered.



RUN T FUN

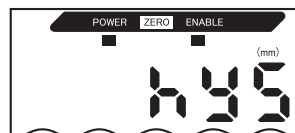

Move between digits.



Increment and decrement the numeric value.



Countermeasures for Setting Errors

If ERROV is displayed, HIGH threshold value – LOW threshold value < hysteresis width.

If an error is displayed, the threshold values have not been updated. Set the values again or change the threshold values.



Linear Output

Output Settings (Monitor Focus)

Linear output refers to the conversion of measurement results to a 3 to 21-mA current output or a -5 to 5-V voltage output. This section describes how to choose either current or voltage output and how to set the linear output range. Match the settings to suit the connected external device.

Enter the output values for any two current values or voltage values to set the output range.

Example:

Setting 0.2 mm to 4 mA Output and 0.8 mm to 20 mA Output (for Current Output)

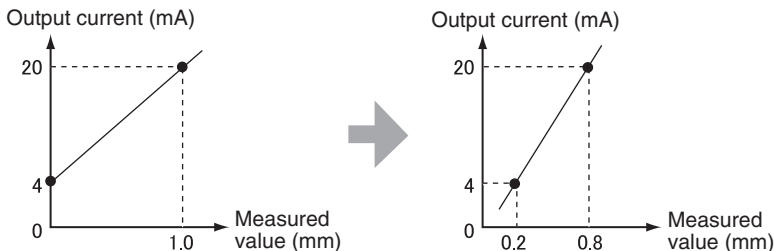

Separate the two specified points by at least 1% of the rated measurement distance for the connected Sensor.

CHECK!

For example, the rated measurement distance for the ZX-ED01T Sensor is 1 mm. Therefore, the two specified points must be separated by 10 μm min.



Using the Zero Reset Function

Zero reset is released when monitor focus is set. Execute the zero reset again after setting monitor focus.

CHECK!

 Zero Reset, p. 112

Section 5 DETAILED SETTINGS

This section describes how to set the output range, using an example of current output with a range with the following conversions: 0.2 mm to 4 mA and 0.8 mm to 20 mA. Change the values in the example to suit a voltage output as necessary.

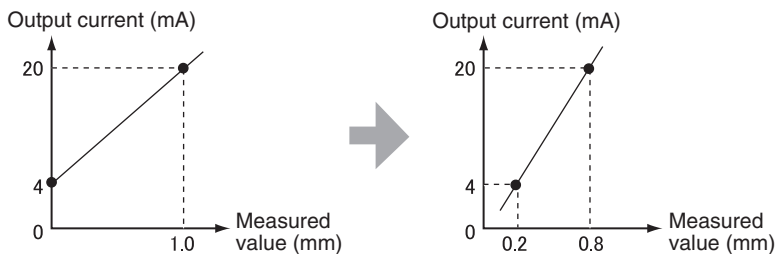

1. Turn OFF the power supply to the Amplifier Unit.
2. Move the current/voltage switch to current output. The switch is found on the bottom of the Amplifier Unit.

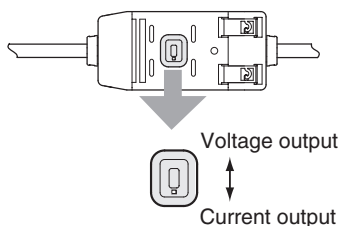

Moving to FUN Mode and SPCL

3. Turn ON the power supply and move the mode switch to FUN.
4. Use the LEFT and RIGHT Keys to display SPCL on the main display.

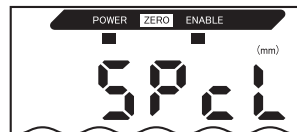

Moving to FOCUS

5. Press the UP or DOWN Key.
The sub-display will flash.
6. Use the Up and DOWN Keys to display SET or ALL.
7. Press the ENT Key.



8. Use the LEFT and RIGHT Keys to display FOCUS on the main display.

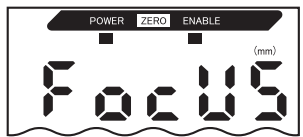

Selecting Current (mA) or Voltage (V) Output

9. Press the UP or DOWN Key.



The sub-display will flash.

10. Display mA.



Always select the same output as the current/voltage switch selection on the bottom of the Amplifier Unit.

CHECK!

Setting the First Point (A)

11. Press the ENT Key.



The display will change to allow the first-point settings to be made. The output current value will be displayed on the main display, and the corresponding measured value will be displayed on the sub-display and the leftmost digit will flash.

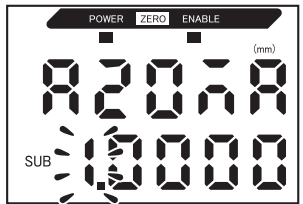

12. Set the output current value and the corresponding measured value for the first point.



Move between digits.



Increment and decrement the numeric value.

Set a measured value within the measurement distance. If scaling or calculation has been set, set a value that reflects those settings.



The flashing digit, i.e., the digit for which a value can be set, will change as shown in the diagram.

CHECK!

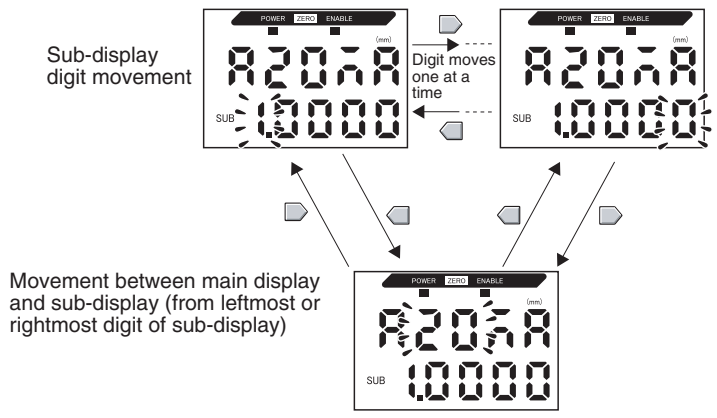

13. Press the ENT Key to confirm the setting.

The setting for the first point will be confirmed. The screen for setting the second point will then be displayed.

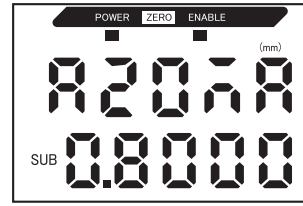

Setting the Second Point (B)

14. Use the same procedure as for the first point to set the output current value and corresponding measurement result for the second point.

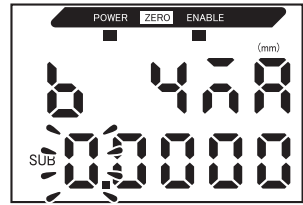

15. Press the ENT Key to confirm the settings.

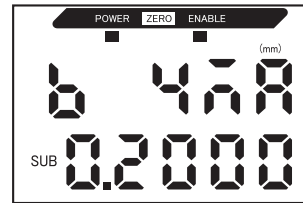

Confirming Completion of Monitor Focus Settings

The display will read OK if monitor focus has been set correctly.

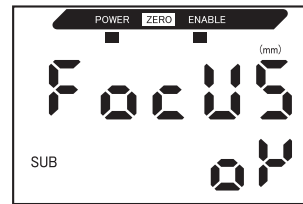

The display will be NG if the settings are incorrect.

If the settings are incorrect, check the following points and execute the monitor focus again.

- Is the measured value set on the sub-display within the measurement distance (with scaling and calculation settings reflected if set)?
- Are the first and second points separated by at least 1% of the rated measurement distance?
- Are the current (or voltage) values for the two points the same?

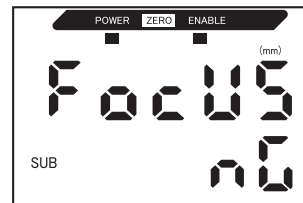

Correcting Linear Output Values

Discrepancies may occur between the linear output current (or voltage) values set on the Amplifier Unit and the actual current (or voltage) values measured due to the conditions for the connected external device or other factors. The linear output correction function can be used to correct this discrepancy.

The output values are corrected by entering the correction value for the current or voltage values for any two points.



Set the monitor focus function and select either current or voltage output beforehand.
p. 103

This section uses a current output as an example. Change the values in this example for voltage output as necessary.

- 1. Connect the linear output to an external ammeter.

Moving to FUN Mode and SPCL

- 2. Turn ON the power supply and set the mode switch to FUN.



- 3. Use the LEFT and RIGHT Keys to display SPCL on the main display.



Moving to LEFT-ADJ

- 4. Press the UP or DOWN Key.
The sub-display will flash.



- 5. Use the UP or DOWN Keys to display SET or ALL.



Section 5
DETAILED SETTINGS

6. Press the ENT Key.

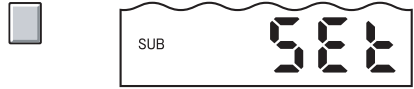

7. Use the LEFT and RIGHT Keys to display L-ADJ on the main display.

The units for the monitor focus settings (mA or V) will be shown on the sub-display.

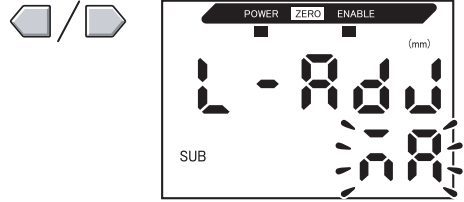

8. Press the ENT Key.

The display will change to the settings for the first point (A). The output current value will be displayed on the main display and the correction will be displayed on the sub-display and the leftmost digit will flash.

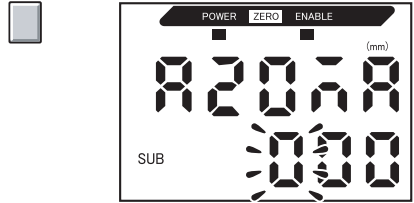

Setting the First Point (A)

9. Set the output current and correction values for the first point.

Adjust the correction value on the sub-display so that the ammeter reading and the output current shown on the main display are the same. The larger the correction value, the larger the output current.

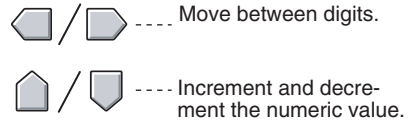

The correction value can be set within the range -999 to 999. To set a negative value, make the leftmost digit of the sub-display flash and change the value.

The flashing digit, i.e., the digit for which a value can be set, will change as shown in the diagram.

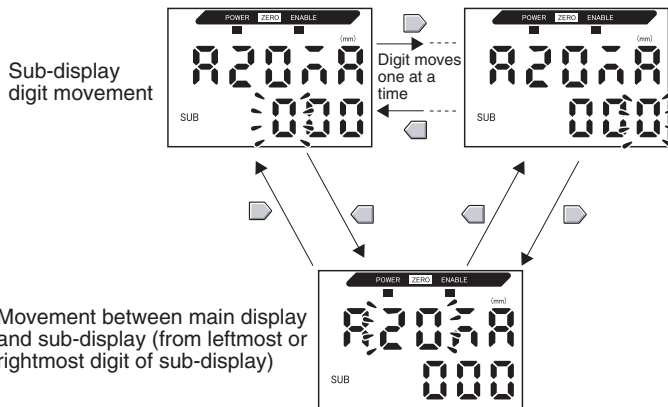

10. Press the ENT Key to confirm the settings.

The correction value for the first point will be confirmed.

The screen for setting the second point correction value will be displayed.



Setting the Second Point (B)

11. Use the same procedure as the first point to set the correction value for the second point.

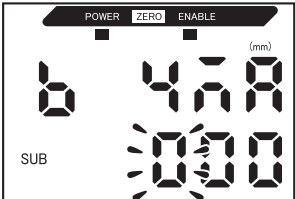

12. Press the ENT Key.



Confirming Setting Results

If linear output correction has been registered correctly, the sub-display will show OK.

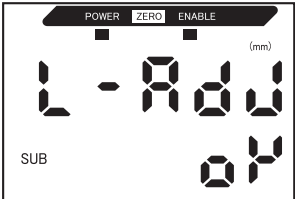

If the correction is not registered correctly, the display will show NG.

Check that the current (or voltage) value for the two points are not the same and execute again.

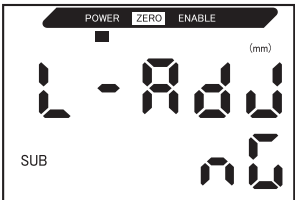

Output Settings for Non-measurement

The linear output method for when a reset is input can be set.

Selection	Outputs	
	Judgement outputs	Linear output
KEEP (default)	The status immediately before measurement is stopped is held and output.	
CLAMP	All OFF	Outputs the set CLAMP value. The following options are available. <ul style="list-style-type: none"> • For current output: 3 to 21 mA or maximum (approx. 23 mA) • For voltage output: -5 to 5 V or maximum (approx. 5.5 V)



For Hold Measurements
Even if KEEP is set, the output before the first hold value is obtained will be the same as CLAMP.

Moving to FUN Mode and SPCL

1. Set the mode switch to FUN.



2. Use the LEFT and RIGHT Keys to display SPCL on the main display.

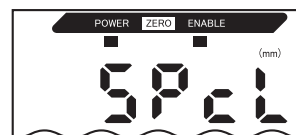

Moving to RESET

3. Press the UP or DOWN Key.

The sub-display will flash.



4. Use the UP and DOWN Keys to display ETC or ALL.



5. Press the ENT Key.



6. Use the LEFT and RIGHT Keys to display RESET on the main display.

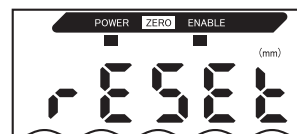

Selecting Output Status for Non-measurement

7. Press the UP or DOWN Key.

The sub-display will flash.



8. Use the UP and DOWN Keys to select either KEEP or CLAMP.



9. Press the ENT Key to confirm the selection.

The output status will be registered.

Next, set the clamp value if CLAMP is selected.



Setting Clamp Values (when CLAMP Is Selected)

10. Use the LEFT and RIGHT Keys to display CLAMP on the main display.

CLAMP cannot be displayed if KEEP has been selected.

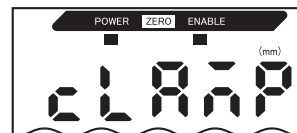

11. Press the UP or DOWN Key.

The sub-display will flash.



12. Select the clamp value.



13. Press the ENT Key to confirm the settings.

The clamp value will be registered.



Setting Judgement Output Timing (Timer)

The timing for judgement outputs can be adjusted to match the operation of external devices.

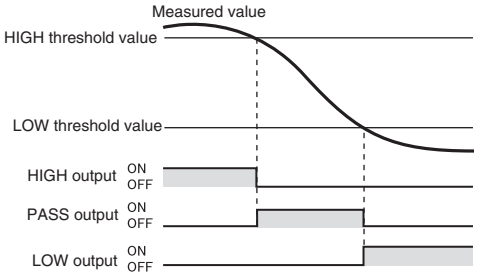
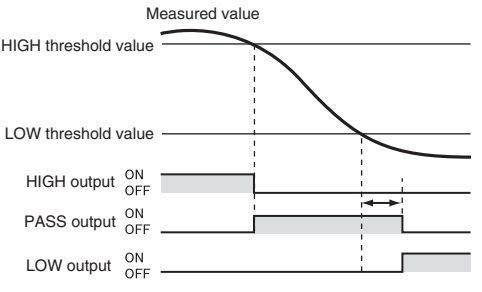
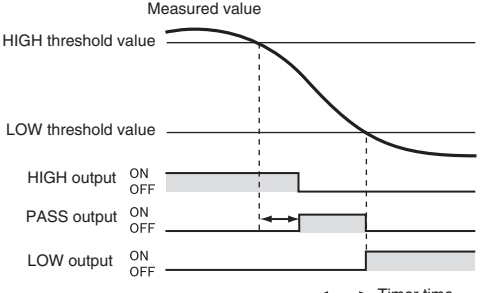
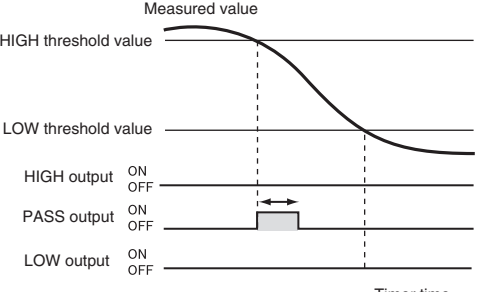
Selection	Details	Details
OFF (default)	Outputs the judgement as soon as the judgment result has been confirmed.	
OFF-D (OFF-delay Timer)	After the measurement result has been confirmed, delays turning OFF the PASS output for the timer time. Also delays turning ON the HIGH and LOW outputs for the timer time.	
ON-D (ON-delay Timer)	After the measurement result has been confirmed, delays turning ON the PASS output for the timer time. Also delays turning OFF the HIGH and LOW outputs for the timer time.	
1-Sht (One-shot Timer)	When the measured value changes from HIGH to PASS or from LOW to PASS, turns ON the PASS output with a pulse width equivalent to the timer time. Neither the HIGH nor the LOW output are output.	

The following description uses the OFF-delay timer as an example. Make the necessary adjustments if other timers are used.

Moving to FUN mode and TIMER

- 1.** Set the mode switch to FUN.



- 2.** Use the LEFT and RIGHT Keys to display TIMER on the main display.

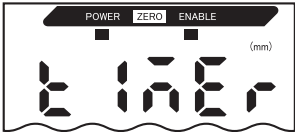

Selecting Timers

- 3.** Press the UP or DOWN Key.
The sub-display will flash.



- 4.** Use the UP and DOWN Keys to select the timer.



- 5.** Press the ENT Key to confirm the selection.
The selected timer will be registered.
If anything other than OFF is selected, use the following procedure to set the timer time.



Setting Timer Time (when a Timer Is Selected)

- 6.** Use the LEFT and RIGHT Keys to display T-TIM on the main display.
T-TIM cannot be displayed if OFF is selected.

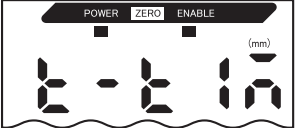

- 7.** Press the UP or DOWN Key.
The leftmost digit on the sub-display will flash.



Section 5 DETAILED SETTINGS

- 8.** Use the Cursor Keys to set the timer time (ms).

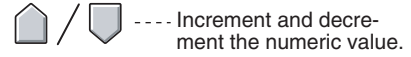
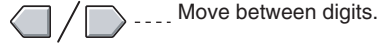

- 9.** Press the ENT Key to confirm the setting.

The timer time will be registered.



Section 6

AUXILIARY FUNCTIONS

☒ Measuring with Multiple Amplifier Units	116
☒ Changing the Number of Display Digits	123
☒ Reversing the Display	124
☒ Adjusting Display Brightness (ECO Display)	126
☒ Using the Zero Reset Function	127
☒ Key Lock Function	132
☒ Initializing Settings Data	133

Measuring with Multiple Amplifier Units

This section describes the settings when Calculating Units are used to connect multiple Amplifier Units.

Performing Calculations

Measurement results can be calculated between 2 Amplifier Units. The expression is set on the CH2 Amplifier Unit and the calculation results are also output from the CH2 Amplifier Unit. Calculations can also be performed between Sensors with different measurement distances.

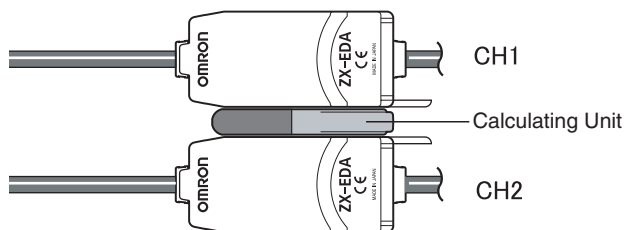

The 3 types of expressions are outlined in the following table.

Expression type	Description
A+B	Finds the sum of the measurement results for two Amplifier Units.
A-B	Finds the difference between the measurement results for two Amplifier Units. (A: CH2 Amplifier Unit; B: CH1 Amplifier Unit)
THICK	Finds the thickness of a sensing object clamped between two Sensor Heads.



CHECK!

The response time for CH2 Amplifier Units to which expressions have been set is increased by 1.0 ms. The response time is also influenced by the setting for the number of samples to average, so the response time will be the response time based on the set number of samples to average + 1.0 ms.



Setting Number of Samples to Average, p. 80



CHECK!

ZX-L-series (Laser Type) Amplifier Units cannot perform calculations.

■ Adding and Subtracting Measurement Results

The expression $A+B$ or $A-B$ is used. All settings are made on the CH2 Amplifier Unit.

Moving to FUN and CALC

1. Set the mode switch to FUN on the CH2 Amplifier Unit.



2. Use the LEFT and RIGHT Keys to display CALC on the main display.



Selecting Expressions

3. Press the UP or DOWN Key.

The sub-display will flash.



4. Use the UP and DOWN Keys to select the expression type.



5. Press the ENT Key to confirm the selection.

The expression will be registered.



■ Finding Thicknesses

The expression THICK is used. Prepare a sensing object of known thickness beforehand (standard sensing object). The settings are all performed on the CH2 Amplifier Unit.

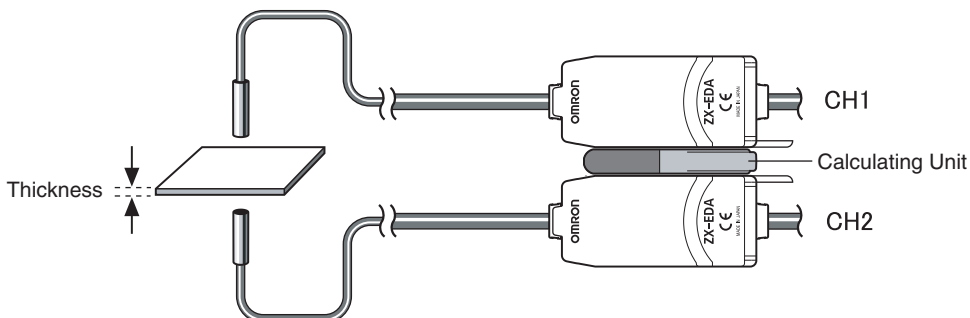

Moving to FUN and CALC

1. Place the standard sensing object in positions.

2. Set the mode switch to FUN on the CH2 Amplifier Unit.



3. Use the LEFT and RIGHT Keys to display CALC on the main display.

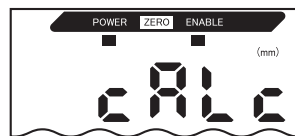

Selecting Expressions

4. Press the UP or DOWN Key.

The sub-display will flash.



5. Use the UP and DOWN Keys to display THICK on the sub-display.



6. Press the ENT Key to confirm the selection.



Setting Thicknesses

- 7.** Use the LEFT and RIGHT Keys to display THICK on the main display.

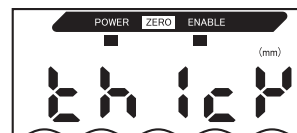

- 8.** Press the UP or DOWN Key.

The leftmost digit of the sub-display will flash.



- 9.** Set the thickness of the standard sensing object.

Enter the actual dimensions of the reference object.

The position of the decimal point can be changed using the next steps.



----- Move between digits.



----- Increment and decrement the numeric value.

- 10.** Press the ENT Key to confirm the setting.

The numeric values will be confirmed and the decimal point will flash.



- 11.** Use the LEFT and RIGHT Keys to move the decimal point.



- 12.** Press the ENT Key to confirm the position of the decimal point.

The scaling values (A and B) are registered for both Amplifier Units.

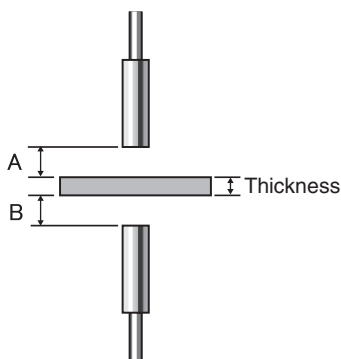

Countermeasures for Setting Errors

If the display shows E-THK, the standard sensing object is outside the measurement distance. (The ENABLE indicator will not be lit.)

Adjust the position of the reference object until the ENABLE indicator is lit on both Amplifier Units and execute the measurement again.

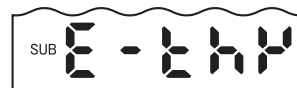

Preventing Mutual Interference between Sensors

Sensor Heads can be installed adjacent to each other if the mutual interference prevention function is used. Mutual interference can be prevented for up to 5 Amplifier Units.

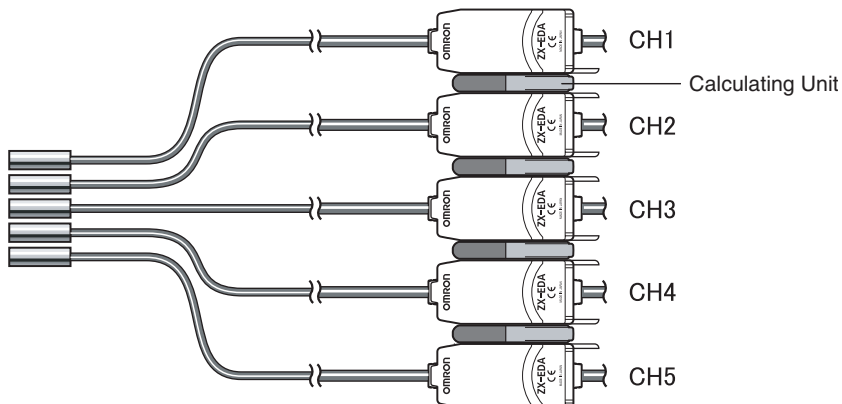

Set the same number of samples to average for all Amplifier Units.

CHECK!



Setting Number of Samples to Average, p. 80

Response time is longer when the mutual interference prevention function is used.

- Response time = (15 ms + response time based on set number of samples to average) × number of Amplifier Units
- If the calculation function is also used, the response time will be longer again by approximately 15 ms.
- Response times for external input signals also become longer by the same amount.



Response time, p. 139



Distance between Sensor Heads when Mutual Interference Prevention Function Is Not Used
p. 32

CHECK!

Settings for mutual interference prevention are made on the CH1 Amplifier Unit.

Moving to FUN and SPCL

1. Set the mode switch to FUN on the CH1 Amplifier Unit.



2. Use the LEFT and RIGHT Keys to display SPCL on the main display.

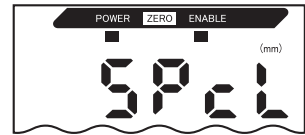

Moving to SYNC

3. Press the UP or DOWN Key.
The sub-display will flash.



4. Use the UP and DOWN Keys to display ETC or ALL.



5. Press the ENT Key.



6. Use the LEFT and RIGHT Keys to display SYNC on the main display.

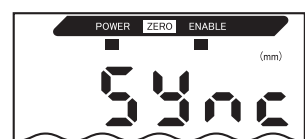

7. Press the UP or DOWN Key.
The sub-display will flash.



8. Use the UP and DOWN Keys to display ON.



9. Press the ENT Key.
Settings for mutual interference prevention can now be made.



Section 6 AUXILIARY FUNCTIONS

Selecting the Number of Units Installed

- 10.** Use the LEFT and RIGHT Keys to display S-CH on the main display.

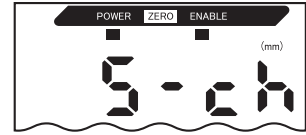

- 11.** Press the UP or DOWN Key.
The sub-display will flash.



- 12.** Use the UP and DOWN Keys to select the total number of Amplifier Units.



CHECK!

Enter the value for the total number of connected Amplifier Units. Mutual interference prevention cannot be set for only some of the Units.

- 13.** Press the ENT Key to confirm the setting.



The number of connected Amplifier Units will be registered.



Setting the Number of Samples to Average

- 14.** Set the same number of samples to average for all Amplifier Units.



Setting Number of Samples to Average,
p. 80

Changing the Number of Display Digits

Select the number of digits for the main and sub-displays in RUN mode. The default setting is 5 digits. When 4 or less digits are set, the digits are disabled from the rightmost digit first.

Moving to FUN and SPCL

1. Set the mode switch to FUN.



2. Use the LEFT and RIGHT Keys to display SPCL on the main display.

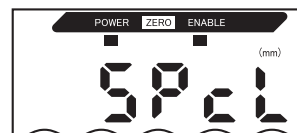

Moving to DIGIT

3. Press the UP or DOWN Key.

The sub-display will flash.



4. Use the UP and DOWN Keys to display DISP or ALL.



5. Press the ENT Key.



6. Use the LEFT and RIGHT Keys to display DIGIT on the main display.



Selecting Number of Digits

7. Press the UP or DOWN Key.

The sub-display will flash.



8. Use the UP and DOWN Keys to select the number of display digits.



9. Press the ENT Key to confirm the setting.



Reversing the Display

The main and sub-digital displays can be reversed, i.e., be turned upside down. The Cursor Key operation will also be reversed. This function is useful when mounting the Amplifier Unit upside down on a device.

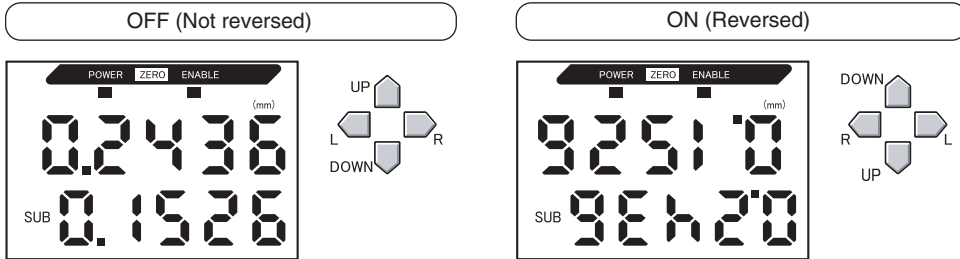

Moving to FUN and SPCL

1. Set the mode switch to FUN.



2. Use the LEFT and RIGHT Keys to display SPCL on the main display.

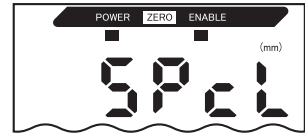

Moving to DREV

3. Press the UP or DOWN Key.

The sub-display will flash.



4. Use the UP and DOWN Keys to display DISP or ALL.



5. Press the ENT Key.



6. Use the LEFT and RIGHT Keys to display DREV on the main display.

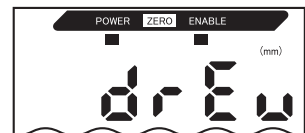

Selecting Whether or Not to Invert Display

7. Press the UP or DOWN Key.

The sub-display will flash.



8. Select either OFF or ON.

OFF: Display not reversed (default)

ON: Display reversed



9. Press the ENT Key to confirm the selection.

The display setting will be registered.

When ON is selected, the display will be reversed.

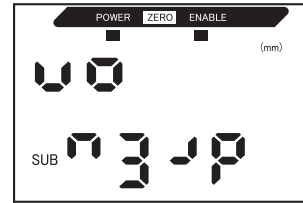

Adjusting Display Brightness (ECO Display)

When the ECO display function is used, the digital displays are not lit, reducing current consumption.

Moving to FUN and SPCL

1. Set the mode switch to FUN.



2. Use the LEFT and RIGHT Keys to display SPCL on the main display.

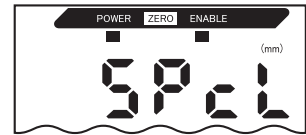

Moving to ECO

3. Press the UP or DOWN Key.

The sub-display will flash.



4. Use the UP and DOWN Keys to display DISP or ALL.



5. Press the ENT Key.



6. Use the LEFT and RIGHT Keys to display ECO on the main display.



Selecting Whether or Not to Use ECO Display

7. Press the UP or DOWN Key.

The sub-display will flash.



8. Select either OFF or ON.

OFF: Normal display (default)
ON: ECO display



9. Press the ENT Key to confirm the selection.

The display setting will be registered.



When ON is selected, the display will become dark.

Using the Zero Reset Function

When the zero reset function is used, the reference value “0” is registered as the height and the measured value can be displayed and output as a positive or negative deviation (tolerance) from the reference value.

In RUN mode, the measured value can be reset to 0 at any timing during measurement.

Example 1: Using the Height of Sensing Object Registered as the Reference Value and the Tolerance Output as the Measured Value

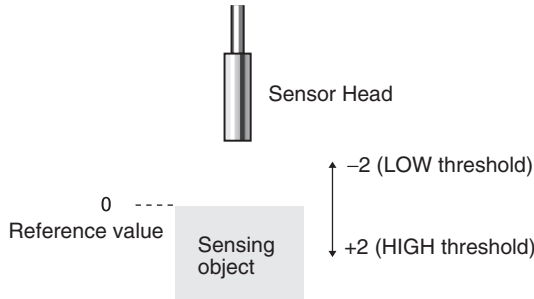

Example 2: Using the Height of Sensing Object as the Measured Value with an Offset Set to 10

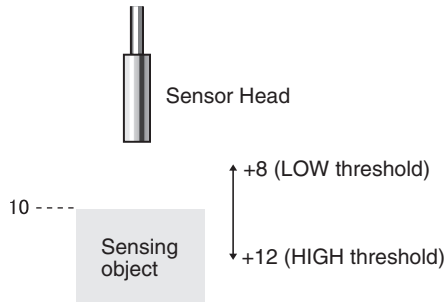

Example 3: Using Zero Reset to Measure Steps in Sensing Object (Zero Reset at Each Measurement)

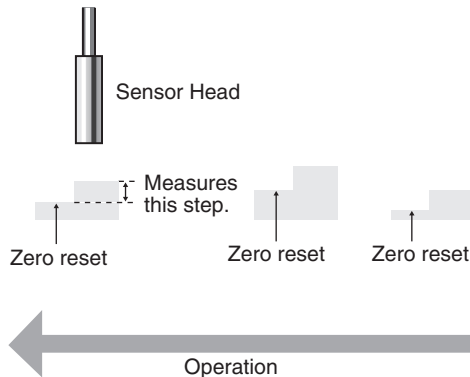

When resetting zero for each measurement, change the settings so that the zero reset memory is disabled. p. 130

Setting Offset Values

Set an offset value when the reference value for zero reset is a value other than 0.

Moving to FUN and SPCL

1. Set the mode switch to FUN.



2. Use the LEFT and RIGHT Keys to display SPCL on the main display.



Moving to ZRDSP

3. Press the UP or DOWN Key.

The sub-display will flash.



4. Use the UP and DOWN Keys to display ETC or ALL.



5. Press the ENT Key.



6. Use the LEFT and RIGHT Keys to display ZRDSP on the main display.

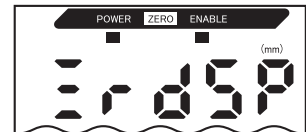

Setting Offset Values

7. Press the UP or DOWN Key.

The leftmost digit of the sub-display will flash.



8. Use the Cursor Keys to set the offset value.



----- Move between digits.



----- Increment and decrement the numeric value.

9. Press the ENT Key to confirm the setting.

The offset value will be registered.





Executing Zero Reset

When the zero reset function is used, the measured value can be reset to a reference value of 0 when the ENT key is pressed or an external signal is input.

If zero reset has already been executed, that value will be overwritten. The settings are saved even if the power is turned OFF (default). This memory setting can be changed so that the zero reset settings are not saved when the power is turned OFF.

 Zero reset memory, p. 130

 **Linear Output**
The measured value when zero reset is executed will be the center value in the linear output range. When monitor focus is set, the measured value will be the center value between the two points set for monitor focus.  Output Settings (Monitor Focus), p. 103

CHECK!

Example

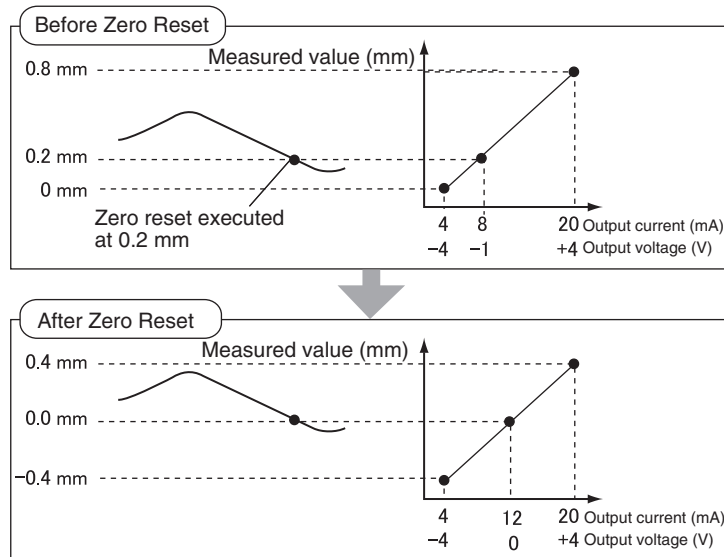

 **CHECK!**

The minimum display value is -19,999 and the maximum is 59,999. If the measurement result after zero reset is less than the minimum, the display will be -19,999. If the measurement result is greater than the maximum, the display will be 59,999. Zero reset can be executed only when the measured value is $\pm 10\%$ of the rated measurement distance.

1. Place the reference sensing object in position.
2. Set the mode switch to RUN.
3. Press the ENT Key for more than one second or input the zero reset signal from an external device (for 800 ms max.).

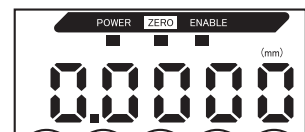

The reference value will be registered and the zero reset indicator will be lit. The tolerance for the registered reference value will be displayed on the main display.

Releasing Zero Reset

1. Set the mode switch to RUN.



2. Hold the ENT and RIGHT Keys down together for about three seconds.



To release zero reset from an external device, input the zero reset signal for one second minimum.

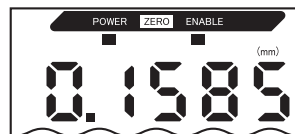

Zero reset will be released and the zero reset indicator will turn OFF.

Saving Zero Reset Level

Select whether or not to hold the measured value zero reset level when the power is turned OFF.

Selection	Details
ON (default)	Saves zero reset level when the power is turned OFF.
OFF	Zero reset is released when the power is turned OFF.



CHECK!

Turn OFF zero reset memory if, as in the example below, the zero point is reset for each measurement. If zero reset memory is enabled, the zero reset level data will be written in the Amplifier Unit non-volatile memory (EEPROM) at each zero reset. The EEPROM can be written a maximum of 100,000 times. Writing the zero reset level for each measurement can, therefore, use up the life of the memory and lead to malfunctions.

Example: Measuring Steps in Sensing Objects

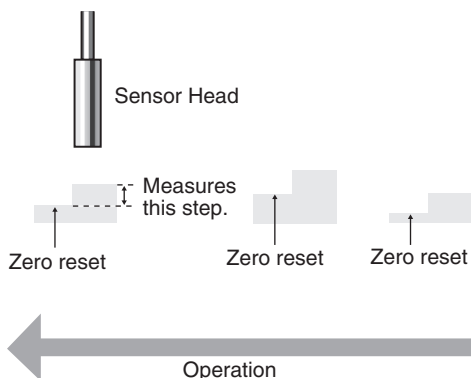

CHECK!

Even if zero reset memory is disabled, the zero reset level will be saved if threshold values or other functions have been changed. Zero reset will continue after startup when these functions have been changed.

Moving to FUN and SPCL

1. Set the mode switch to FUN.



2. Use the LEFT and RIGHT Keys to display SPCL on the main display.

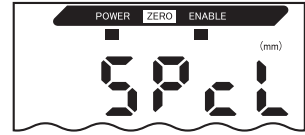

Moving to ZRMEM

3. Press the UP or DOWN Key.

The sub-display will flash.



4. Use the UP and DOWN Keys to display ETC or ALL.



5. Press the ENT Key.



6. Use the LEFT and RIGHT Keys to display ZRMEM on the main display.

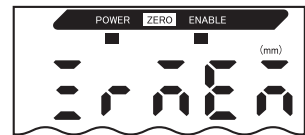

Selecting Whether or Not to Enable Zero Reset Memory

7. Press the UP or DOWN Key.

The sub-display will flash.



8. Use the UP and DOWN Keys to select ON or OFF.

ON: Zero reset memory enabled (default)
OFF: Zero reset memory disabled



9. Press the ENT Key to confirm the selection.

The zero reset memory setting will be registered.



Key Lock Function

The key lock function disables all Amplifier Unit keys. Once the keys have been disabled, no key input will be accepted until the lock is released. This function is useful to prevent inadvertent changes to settings.

The mode and threshold switches are still enabled even when the key lock function is ON.

Setting the Key Lock

1. Set the mode switch to FUN.



2. Hold down the UP, DOWN, RIGHT, and LEFT Keys at the same time.

LOCK will be displayed on the main display and "-----" will be displayed on the sub-display.

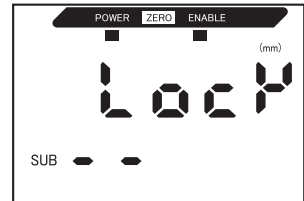
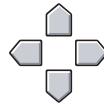

3. Release the keys once OK is displayed on the sub-display.

The keys will be locked.



Releasing the Key Lock

1. Set the mode switch to FUN.



2. Hold down the UP, DOWN, RIGHT, and LEFT Keys at the same time.

FREE will be displayed on the main display and "-----" will be displayed on the sub-display.

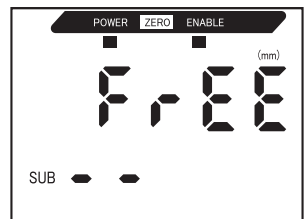
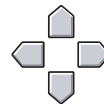

3. Release the keys once OK is displayed on the sub-display.

The key lock will be released.



Initializing Settings Data

This function resets all settings to their default values.

Linearity adjustments, however, are not initialized using this function. To initialize linearity adjustment data, perform initialization in linearity adjustment mode.



Initializing Adjustment Settings, p. 59

Function	Default Value
No. of samples to average	64
Hysteresis width	The default differs depending on the connected Sensor Head. <ul style="list-style-type: none"> • ZX-EDR5T: 0.0003 • ZX-ED01T: 0.0004 • ZX-ED02T: 0.0008 • ZX-EM02T: 0.0008 • ZX-EM07MT: 0.003 • ZX-EV04T: 0.0016 • ZX-EM02HT: 0.0008
Hold	OFF
Timer	OFF
Special functions	CLOSE
Scaling	OFF
Monitor focus	At 0 mm: 4 (mA) At rated measurement distance: 20 (mA)
Linear output correction	No correction
Display reverse	OFF
ECO display	OFF
No. of display digits	5 digits (all)
Non-measurement settings	KEEP
Zero reset memory	ON
HIGH threshold	The default differs depending on the connected Sensor Head. <ul style="list-style-type: none"> • ZX-EM07MT: 59.999 (mm) • Other Sensor Heads: 5.9999 (mm)
LOW threshold	The default differs depending on the connected Sensor Head. <ul style="list-style-type: none"> • ZX-EM07MT: -19.999 (mm) • Other Sensor Heads: -1.9999 (mm)

Section 6 AUXILIARY FUNCTIONS

1. Set the mode switch to FUN.



2. Use the LEFT and RIGHT Keys to display INIT on the main display.

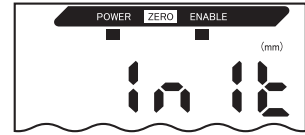

3. Press and hold down the ENT Key.

The sub-display will display "----".



4. Release the ENT Key once OK is displayed on the sub-display.

The settings will be initialized.



APPENDICES

☒ Troubleshooting	136
☒ Error Messages and Countermeasures	137
☒ Q&A	138
☒ Glossary	139
☒ Specifications and Dimensions	140
☒ Characteristic Data	148
☒ Quick Reference for Displays	157

Troubleshooting

This section describes countermeasures for temporary hardware problems. Check the malfunction in this section before sending the hardware for repair.





Problem	Probable cause and possible countermeasure	Pages
POWER indicator not lit.	<ul style="list-style-type: none"> • Is the power supply device connected correctly? • Is the supply voltage below the rated range (12 to 24 VDC \pm10%)? 	p. 38
Device restarts during operation.	<ul style="list-style-type: none"> • Is the power supply device connected correctly? • Are the Interface and Calculating Units connected correctly? 	p. 38 p. 34
Judgements not output to external device.	<ul style="list-style-type: none"> • Are all cables connected correctly? • Is the signal line disconnected? • Are the judgement hold or reset inputs short-circuited? 	p. 38
No input signal received.	<ul style="list-style-type: none"> • Are all cables connected correctly? • Is the signal line disconnected? 	p. 38
No communications with personal computer.	<ul style="list-style-type: none"> • Is the cable connected correctly? • Is the Interface Unit connected correctly? • Is the switch under the Interface Unit on the side without the tab? • Is the connector pin arrangement correct? 	p. 34 p. 146
Strange linear output levels.	<ul style="list-style-type: none"> • Is the switch on the bottom of the Amplifier Unit set to the correct position? • Has the correct selection (voltage/current) been made in the monitor focus settings? • Linear output levels can be fine-tuned. 	p. 103
Nothing displayed on main display or sub-display.	<ul style="list-style-type: none"> • Has the number of display digits been set to zero? 	p. 123
The main display remains on "----".	<ul style="list-style-type: none"> • Has a timing input been made while hold is enabled and the trigger type has been set to TIMIG? • If the hold function is enabled and the trigger type is UP or DOWN, has the self-trigger level been set to an appropriate value? 	p. 81

Error Messages and Countermeasures







This section outlines the error messages displayed on the main display and the countermeasures for those messages.

Display	Error	Countermeasure	Pages
E-CHL	There are two Sensors but only one Amplifier Unit connected.	<ul style="list-style-type: none"> If two Amplifier Units have been connected, turn OFF the power supply and check that the Amplifier and Calculating Units are connected correctly. If only one Amplifier Unit is being used, connect another Amplifier Unit temporarily and turn OFF the two-sensor operation, or initialize the settings data. 	p. 25 p. 34 p. 116 p. 133
E-DAT	Two-sensor operation communications data error	<ul style="list-style-type: none"> Change the mode for the CH1 Amplifier Unit to RUN. Turn OFF the power supply and check that the Amplifier and Calculating Units are connected correctly. Replace the Amplifier Unit or the Calculating Unit if the above countermeasures do not solve the problem. 	p. 25 p. 34
E-EEP	EEPROM data error	Hold down the ENT Key for three seconds or longer. Once the data has been cleared, cycle the power supply. Replace the Amplifier Unit if the above countermeasure does not solve the problem.	p. 25
E-HED	The Sensor Head is disconnected.	Turn OFF the power supply, check that the Sensor Head is connected correctly, and then turn ON the power supply. Replace the Sensor Head if the above countermeasure does not solve the problem.	p. 30
E-SEN	The Sensor Head is disconnected or other factors are causing it to malfunction.	Turn OFF the power supply, check the connection for the Sensor Head, and then turn ON the power supply again. Replace the Sensor Head if the above countermeasure does not solve the problem.	p. 30
E-SHT	One or all of the judgement outputs are short-circuited.	Turn OFF the power supply, check that the HIGH, PASS, and LOW output lines are not short-circuited, then turn ON the power supply again.	p. 38
E-THK	The thickness T is not set for thickness operation.	Set an appropriate thickness T.	p. 74
ERRLH	An attempt was made to set a numeric value larger than the HIGH threshold value to the LOW threshold value.	Input correct threshold values.	p. 97
	HIGH threshold – LOW threshold < hysteresis width		
ERRHL	An attempt was made to set a numeric value smaller than the LOW threshold value to the HIGH threshold value.	Input correct threshold values.	p. 97
	HIGH threshold – LOW threshold < hysteresis width		
ERROV	The set numeric value is too large.	Input an appropriate numeric value.	p. 50
	HIGH threshold – LOW threshold < hysteresis width		
ERRTB	Linearity adjustment failed.	Confirm the selected material and sensing object position, then perform adjustment again.	p. 54
ERRUD	The set numeric value is too small.	Input an appropriate numeric value.	p. 50

Q&A

Question	Answer
Can the cable between Sensor Heads and the Preamplifiers be extended?	No. If the cable is extended, measurement precision is lost.
Can calculations be performed with ZX-L-series Smart Sensors (Laser Type) ?	No. The ZX-E-series Smart Sensors (Inductive Displacement Type) and ZX-L-series Smart Sensors (Laser Type) are not compatible.
Can the ZX-SF11 Interface Unit used with the ZX-L-series Smart Sensors (Laser Type) be used with the ZX-E-series Smart Sensors (Inductive Displacement Type)?	Yes, if the Interface Unit is version 2.0 or later. If the Interface Unit is an earlier version, contact your OMRON representative. (The Interface Unit version can be checked with the Smart Monitor.)
Can the ZX-CAL Calculation Unit used with the ZX-L-series Smart Sensors (Laser Type) be used with the ZX-E-series Smart Sensors (Inductive Displacement Type)?	Yes. However, only two Amplifier Units can be connected.
Why does an error occur and settings cannot be made when teaching or directly inputting threshold values?	Threshold values cannot be set using teaching or by direct input if the following condition is not met: <ul style="list-style-type: none"> • HIGH threshold value – LOW threshold value > hysteresis width  p. 97
When scaling is executed, an error appears on the sub-display and settings cannot be made.	Scaling cannot be set for one of the following reasons: <ul style="list-style-type: none"> • Scaling has been attempted when the measured value is outside the measurement distance range. • When two-point scaling has been executed, the distance between the measured values for the two points is not 1% or more of the measurement distance.  p. 95
When monitor focus is executed, why does an error appear on the sub-display and the settings cannot be made?	Monitor focus settings cannot be made when the distance between the two specified points is not 1% or more of the measurement distance.  p. 103
When entering the thickness for thickness calculation, why does an error appear on the sub-display and the settings cannot be made?	The present value is outside the measurement distance. Place the sensing object within the measurement distance range and then enter the thickness.  p. 74
Can calculations be performed with 3 or more Amplifier Units?	Contact your OMRON representative.
Can calculations be performed when Sensor Heads with different measurement distances are connected to 2 Amplifier Units?	Yes, if both Sensors are ZX-E-series Smart Sensors (Inductive Displacement Type).
The sensing object is made of copper. What material should I select for linearity adjustment?	Use the default, aluminum (AL).
When linearity adjustment is executed, why does an error occur and linearity is not adjusted?	Occasionally linearity cannot be adjusted due to the surface status of the sensing object used, e.g., the surface is rough or has been processed. Initialize the linearity adjustment data and use the default settings.
The main display does not change to zero even when sensing objects are in contact with the Sensor Head.	Sometimes the status of the sensing object surface, e.g., the surface is rough or has been processed, prevents the display from changing to zero even when the sensing objects are in contact when the default linearity adjustment values are used. Either execute linearity adjustment or execute a zero reset first.

Glossary

Term	Explanation
Response time	<p>Response time is the time from when the Sensor measures a distance to when the value is output (either as linear output or judgement output).</p> <p>The response time changes depending on the settings for the number of samples to average, calculations, and mutual interference prevention.</p>
Measured value	<p>The measured value is the measurement result displayed on the main display of the Amplifier Unit in RUN and T modes.</p> <p>The measured value is the value after all set processing has been completed, e.g., linearity adjustment, number of samples to average, scaling, calculations, hold, and previous value comparison.</p> <p> p. 51</p>
Present value	<p>The present value is the current measurement result for the target Amplifier Unit.</p> <p>Some set processing, such as linearity adjustment, number of samples to average, and scaling, have been completed for the current measured value, but calculation, hold, and previous value comparison settings are not reflected.</p> <p>Press the LEFT or RIGHT Key in RUN mode to display the present value on the sub-display.</p> <p> p. 51</p>
Linearity	<p>The linearity is given as the error in an ideal straight line displacement output when measuring the standard sensing object. The linearity shows how closely the linear output maintains a linear relationship to the displacement of the sensing (i.e., it shows the accuracy of the linear output).</p> <p>More precise linearity can be obtained with the ZX-E Smart Sensors by performing linearity adjustment.</p> <p> p. 54</p>
Linear output	<p>The linear output is analog data output from the linear output line. Either a current or voltage output can be selected.</p> <p>The linear output is made based on the display value and monitor focus settings.</p> <p>The actual value output (the output value) can be displayed on the sub-display by pressing the LEFT or RIGHT Key in RUN mode.</p> <p> p. 51</p>
Judgement outputs	<p>“Judgement outputs” is a general term for the HIGH, PASS, and LOW outputs. The judgement outputs are made in RUN and T mode based on the display values and the threshold, hysteresis width, and timer settings. The judgement output is held while judgement output hold input is ON.</p>
Smart Monitor	<p>The Smart Monitor is software (sold separately) for Windows 98 or 2000. Use Smart Monitor software to communicate, via an Interface Unit, with ZX-E-series Smart Sensors. This means that measurement settings can be made from personal computers, settings data saved, measurement results displayed as graphs, and data logged.</p> <p>Smart Monitor version 2 or later must be used with ZX-E-series Smart Sensors.</p> <p> p. 24</p>
Measurement distance	<p>The measurement distance is the range (distance) that measurement is possible for the connected Sensor Head.</p> <p> p. 143</p>
Sampling period	<p>Sampling period is the time over which the sensing object is measured when the hold function is being used.</p> <p>The sampling period is determined by the trigger mode and the delay time.</p> <p> p. 81</p>

Specifications and Dimensions

ZX-EDA11 and ZX-EDA41 Amplifier Units

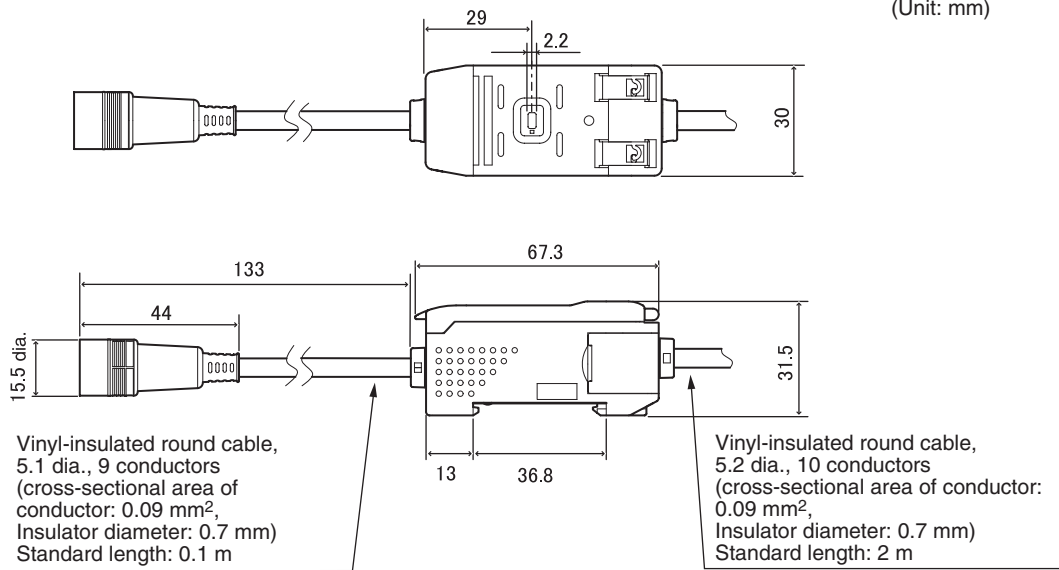

	ZX-EDA11	ZX-EDA41
Measurement period	150 μs	
Possible settings for number of samples to average (See note 1.)	1, 2, 4, 8, 16, 32, 64, 128, 256, 512, 1024, 2048, or 4096	
Linear output (See note 2.)	Current output: 4 to 20 mA/F.S., Max. load resistance: 300 Ω Voltage output: ±4 V (± 5 V, 1 to 5 V, See note 3.), Output impedance: 100 Ω	
Judgement outputs (3 outputs: HIGH/PASS/LOW)	NPN open-collector outputs, 30 VDC, 50 mA max. Residual voltage: 1.2 V max.	PNP open-collector outputs, 30 VDC, 50 mA max. Residual voltage: 2 V max.
Judgement output hold input	ON: Short-circuited with 0-V terminal or 1.5 V or less OFF: Open (leakage current: 0.1 mA max.)	ON: Supply voltage short-circuited or within supply voltage 1.5 V max. OFF: Open (leakage current: 0.1 mA max.)
Zero reset input		
Timing input		
Reset input		

	ZX-EDA11	ZX-EDA41
Functions	Measured value display Present value display Output value display Set value display Resolution display ENABLE indicator Zero reset indicator Power ON indicator Judgement indicator ECO mode Display reverse	Display digit limit Zero reset Zero reset memory Previous value comparison Initialization Linearity initialization Teaching Direct threshold value setting Hysteresis width setting Scaling Linearity adjustment
		Monitor focus Linear output correction Peak hold Bottom hold Sample hold Peak-to-peak hold Average hold Delay hold Delay time setting ON-delay timer OFF-delay timer
		One-shot timer Timing inputs Self-up trigger Self-down trigger (A-B) calculations (See note 4.) (A+B) calculations (See note 4.) Thickness calculation (See note 4.) Mutual interference prevention (See note 4.) Key lock Clamp value setting
Indications	Judgement indicators: HIGH (orange), PASS (green), LOW (yellow), 7-segment main display (red), 7-segment sub-display (yellow), power ON (green), zero reset (green), enable (green)	
Voltage influence (including Sensor)	0.5% F.S. of linear output value at $\pm 20\%$ of power supply voltage	
Power supply voltage	12 to 24 VDC $\pm 10\%$, Ripple (p-p): 10% max.	
Power consumption	3.4 W max. (Sensor connected) (Power supply voltage: 24 V, Current consumption: 140 mA max.)	
Ambient temperature	Operating and storage: 0 to 50°C (with no icing or condensation)	
Ambient humidity	Operating and storage: 35% to 85% (with no condensation)	
Insulation resistance	20 M Ω min. at 500 VDC	
Dielectric strength	1,000 VAC, 50/60 Hz for 1 min	
Vibration resistance (destructive)	10 to 150 Hz, 0.7-mm double amplitude 80 min each in X, Y, and Z directions	
Shock resistance (destructive)	300 m/s ² 3 times each in six directions (up/down, left/right, forward/backward)	
Connection method	Prewired (standard cable length: 2 m)	
Weight (packed state)	Approx. 350 g	
Materials	Case: PBT (polybutylene terephthalate), Cover: Polycarbonate	
Accessories	Instruction sheet	

- Notes:**
- The response speed of the linear output is calculated as the measurement period x (No. of samples to average setting + 1).
The response speed of the judgement outputs is calculated as the measurement period x (No. of samples to average setting + 1).
 - The output can be switched between current output and voltage output using a switch on the bottom of the Amplifier Unit.
 - Setting is possible via the monitor focus function.
 - A Calculating Unit is required.

ZX-ED□□T and ZX-EM□□T Sensor Heads

(Unit: mm)

Sensor Heads

ZX-EDR5T

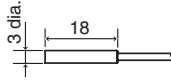

ZX-ED01T

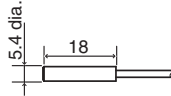

ZX-ED02T

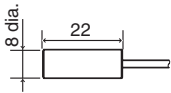

Preamplifier
(Same for all models)

Round vinyl-insulated coaxial cable,
1 core, 2.5 dia.
(ZX-EDR5: 1.7 dia.)
Standard length: 2 m

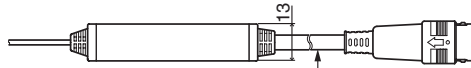
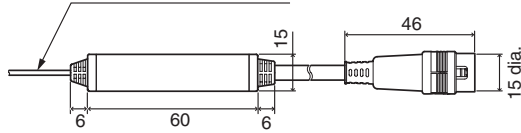

Round vinyl-insulated coaxial cable,
9 cores, 5.1 dia.
Standard length: 0.2 m

ZX-EM02T

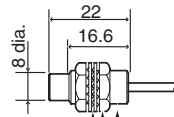
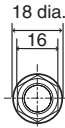

M10×1
Two clamping nuts
Two toothed washers

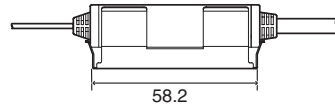
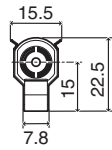

ZX-EM07MT

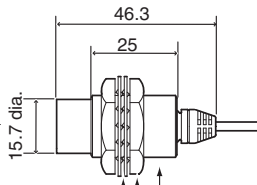
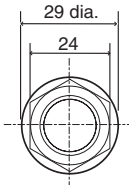

M18×1
Two clamping nuts
Two toothed washers



ZX-EV04T

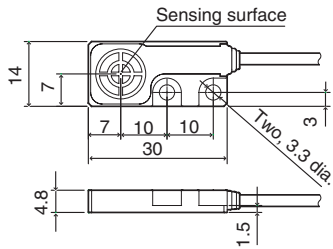

Sensor mounting hole dimensions

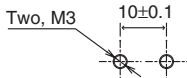

ZX-EM02HT

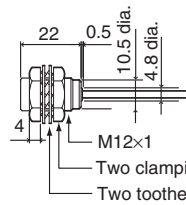
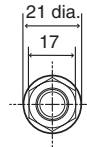

M12×1
Two clamping nuts
Two toothed washers

	ZX-EDR5T	ZX-ED01T	ZX-ED02T	ZX-EM02T	ZX-EM07MT	ZX-EV04T	ZX-EM02HT
Shape	3 dia.	5.4 dia.	8 dia.	M10	M18	30 × 14 × 4.8 mm	M12
Sensing object	Magnetic metals (Measurement distance ranges and linearities are different for non-magnetic metals. Refer to <i>Characteristic Data</i> on page 148.)						
Measurement distance	0 to 0.5 mm	0 to 1 mm	0 to 2 mm	0 to 2 mm	0 to 7 mm	0 to 4 mm	0 to 2 mm
Standard sensing object	18 × 18 mm	18 × 18 mm	30 × 30 mm	30 × 30 mm	60 × 60 mm		45 × 45 mm
	T = 3 mm, material: S50C						
Resolution (See note 1.)	(1.0 μm)						
Linearity (See note 2.)	±0.5% F.S. (See note 3.)					±1.0% F.S. (See note 3.)	
Temperature characteristic	0.15% F.S./°C (See note 4.)	0.07% F.S./°C (See note 4.)				0.1% F.S./°C (See note 5.)	
Ambient temperature	Operating/storage: 0 to 50°C	Operating: -10 to 60°C Storage: -20 to 70°C				Operating/storage (See note 7.) Head: -10 to 200°C Pre-amplifier: -10 to 60°C	
	With no icing or condensation						
Ambient humidity	Operating/storage: 35% to 85% (with no condensation)						
Insulation resistance	500 MΩ min. (at 500 VDC)						
Dielectric strength	1,000 VAC, 50/60 Hz for 1 min. between charged parts and the case						
Vibration resistance (destruction)	10 to 55 Hz, 1.5-mm double amplitude 2 hrs each in X, Y, and Z directions						
Shock resistance (destruction)	500 m/s ² , 3 times each in X, Y, and Z directions						
Degree of protection (Sensor Head only)	IEC60529, IP65	IEC60529, IP67				IEC60529, IP60 (See note 6.)	
Materials	Sensor Head	Brass	Stainless steel (SUS)	Brass		Zinc (nickel-plated)	Brass
	Sensing surface	Heat-resistant ABS					PEEK
	Pre-amplifier	PES					
Weight (packed state)	Approx. 120 g	Approx. 140 g	Approx. 140 g	Approx. 140 g	Approx. 160 g	Approx. 130 g	Approx. 160 g

F.S.: Full scale of measurement

- Notes:**
1. Resolution: The resolution is the deviation ($\pm 3\sigma$) in the linear output when connected to the Amplifier Unit. The above values indicate the deviations observed 30 minutes after the power is turned ON. (The resolution is measured with the standard sensing object at 1/2 of the measurement distance range, with the Amplifier Unit set for the maximum average count of 4,096 per period.)
The resolution is given as the repeat accuracy for a stationary workpiece, and is not an indication of the distance accuracy. The resolution may be adversely affected under strong electromagnetic fields.
 2. Linearity: The linearity is given as the error in an ideal straight line displacement output when measuring the standard sensing object (varies with the object being measured).
 3. The value following linearity adjustment using a standard sensing object for an ambient temperature of 25°C.
 4. Temperature characteristic: At the same temperature as the Amplifier Unit, and with the standard sensing object at 1/2 of the measurement distance range.
 5. Temperature characteristic: The temperature of the Sensor Head only, and with the standard sensing object at 1/2 of the measurement distance range.
 6. Do not use in moist environments because the case is not waterproof.
 7. Even when operated within the specified temperature range, using in locations subject to extreme temperature fluctuations may result in deterioration of Sensor characteristics.

ZX-CAL2 Calculating Unit

(Unit: mm)

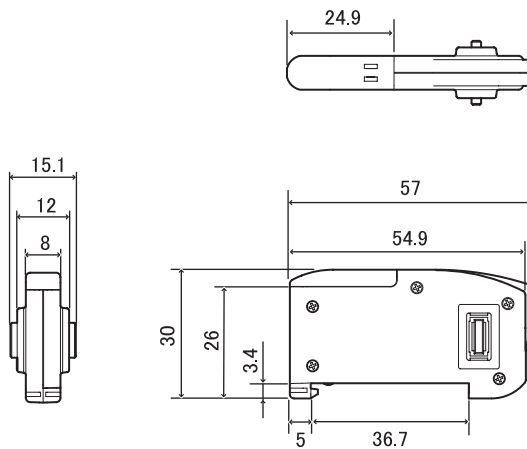

Applicable Amplifier Units	ZX Series
Current consumption	12 mA max. (supplied from the Smart Sensor Amplifier Unit)
Ambient temperature	Operating: 0 to 50°C, Storage: -15 to 60°C (with no icing or condensation)
Ambient humidity	Operating and storage: 35% to 85% (with no condensation)
Connection method	Connector
Dielectric strength	1,000 VAC, 50/60 Hz for 1 min
Insulation resistance	100 MΩ (at 500 VDC)
Vibration resistance (destructive)	10 to 150 Hz, 0.7-mm double amplitude 80 min each in X, Y, and Z directions
Shock resistance (destructive)	300 m/s ² 3 times each in six directions (up/down, left/right, forward/backward)
Materials	Display: Acrylic, Case: ABS resin
Weight (packed state)	Approx. 50 g

ZX-SF11 Interface Unit

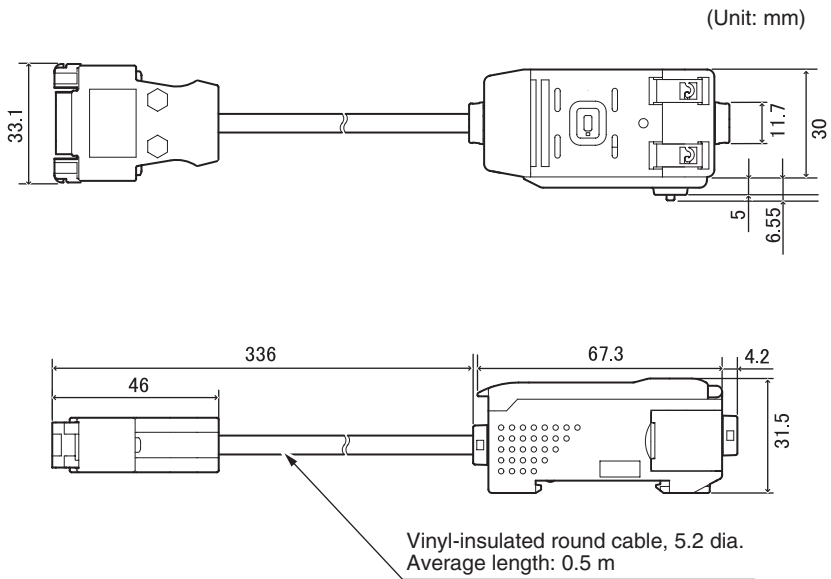

Connector pin arrangement

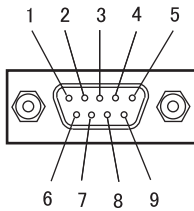

Pin No.	Name
1	N.C.
2	RD
3	SD
4	N.C.
5	SG
6	N.C.
7	N.C.
8	N.C.
9	N.C.

Power supply voltage		12 to 24 VDC \pm 10%, Ripple (p-p) 10% max. Supplied from Amplifier Unit
Current consumption		Power supply voltage: 12 V, Current consumption: 60 mA max. (Excluding Amplifier Unit current consumption and output current.)
Connectable Amplifier Units		ZX Series
No. of Amplifier Units connectable		Up to 5 (Two Calculating Units max.)
Communications functions	Communications port	RS-232C port (9-pin D-sub connector)
	Protocol	CompoWay/F
	Baud rate	38,400 bps
	Data configuration	Data bits: 8, Parity: None; Start bits: 1 Stop bits: 1, Flow control: None
Indicators		Power ON (green), Communicating with Sensor (green), Sensor communications error (red) Communicating with external terminal (green), External terminal communications error (red)
Protection circuits		Reverse power supply wiring protection
Ambient temperature		Operating: 0 to 50°C, Storage: -15 to 60°C (with no icing or condensation)
Ambient humidity		Operating and storage: 35% to 85% (with no condensation)
Dialectic strength		1,000 VAC, 50/60 Hz for 1 min
Insulation resistance		20 M Ω min. (at 500 VDC)
Case materials		Case: PBT (polybutylene terephthalate), Cover: Polycarbonate
Weight (packed state)		Approx. 350 g

Characteristic Data

Linearity for Sensors (after Adjusting Linearity with Standard Sensing Object)

ZX-EDR5T

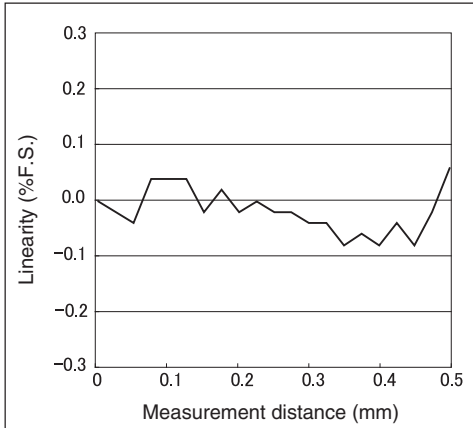

ZX-ED01T

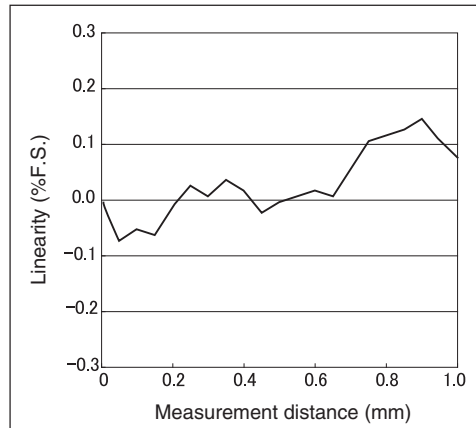

ZX-ED02T/EM02T

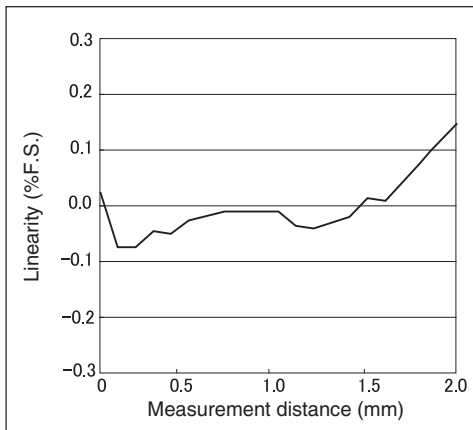

ZX-EM07MT

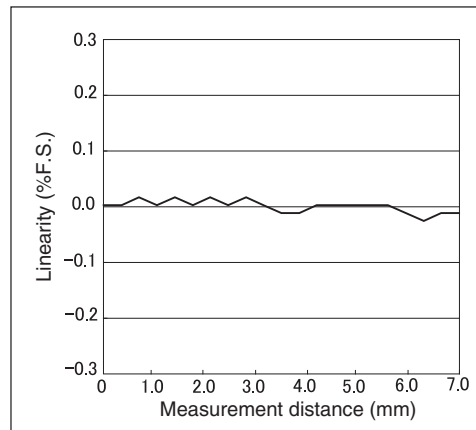

ZX-EV04T

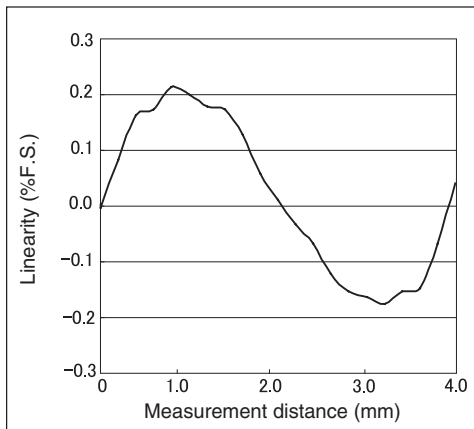

ZX-EM02HT

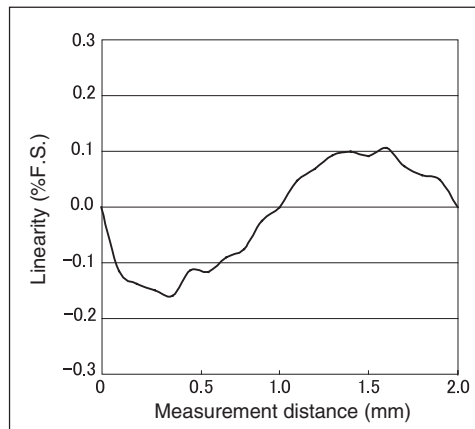

Measuring Sensing Objects of Different Sizes after Adjusting Linearity with Standard Sensing Object

ZX-EDR5T

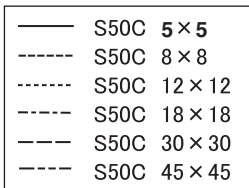
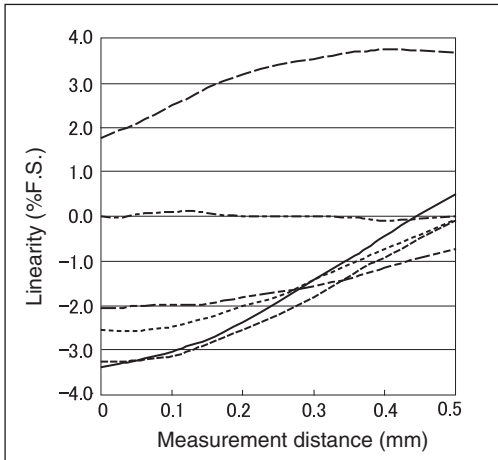

ZX-ED01T

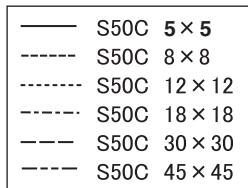
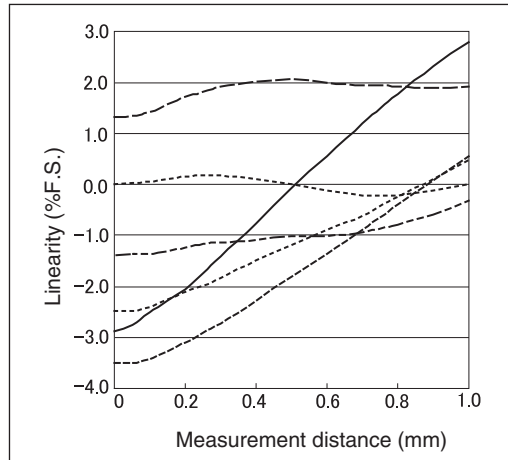

ZX-ED02T/EM02T

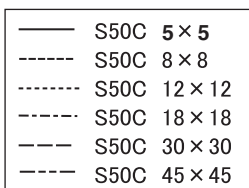
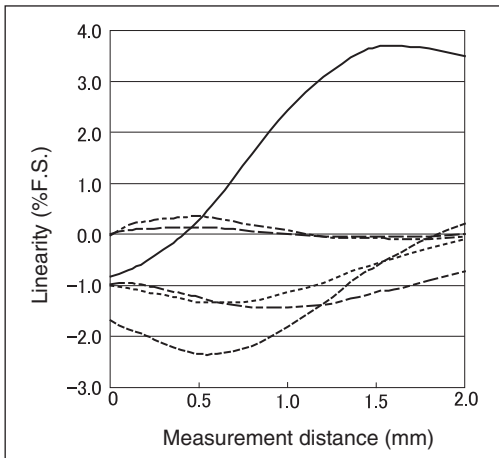

ZX-EM07MT

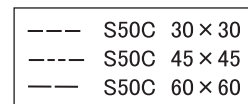
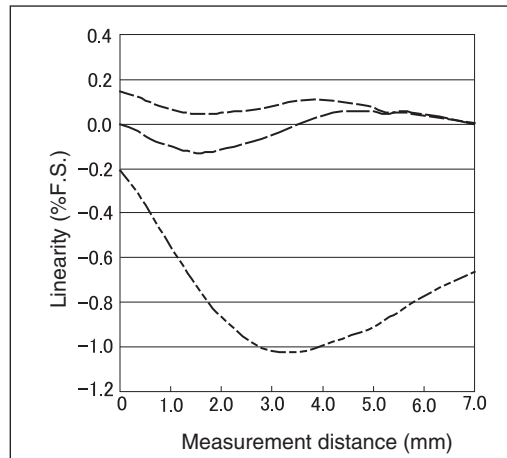

ZX-EV04T

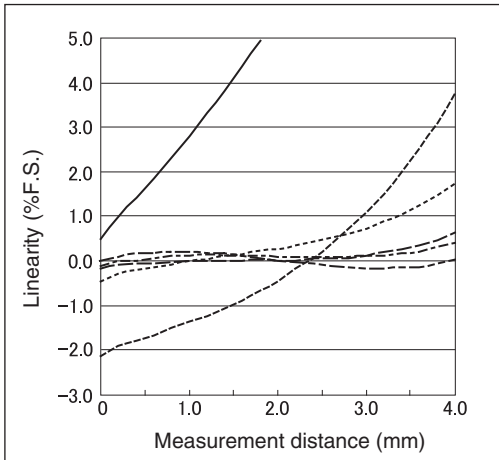

—	S50C 8 × 8
- - - -	S50C 12 × 12
· · · · ·	S50C 18 × 18
- - - -	S50C 30 × 30
- - - -	S50C 45 × 45
- - - -	S50C 60 × 60

ZX-EM02HT

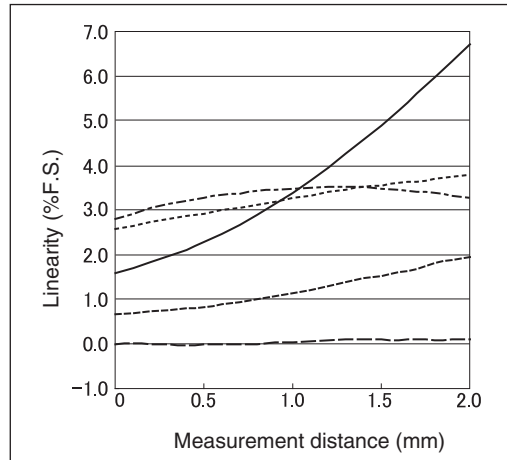

—	S50C 8 × 8
- - - -	S50C 12 × 12
· · · · ·	S50C 18 × 18
- - - -	S50C 30 × 30
- - - -	S50C 45 × 45
- - - -	S50C 60 × 60

Adjusting Linearity for Each Sensing Object

(The measured sensing object is the same as the object for which linearity was adjusted.)

ZX-EDR5T

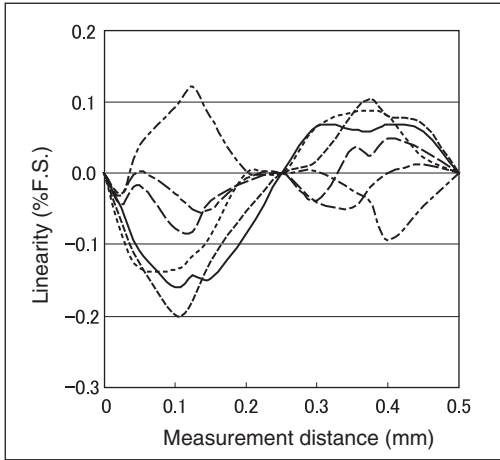

- S50C 5 × 5
- - - S50C 8 × 8
- · · S50C 12 × 12
- · - S50C 18 × 18
- - - S50C 30 × 30
- - - S50C 45 × 45

ZX-ED01T

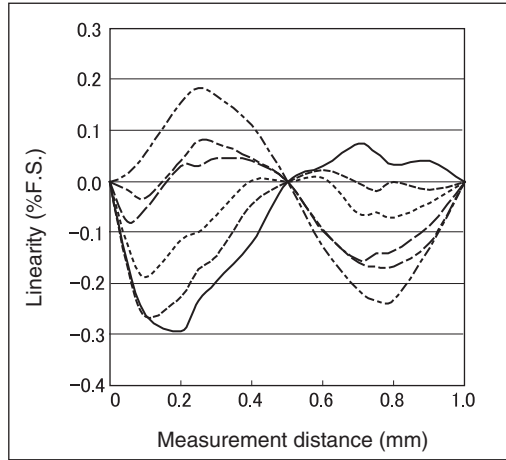

- S50C 5 × 5
- - - S50C 8 × 8
- · · S50C 12 × 12
- · - S50C 18 × 18
- - - S50C 30 × 30
- - - S50C 45 × 45

ZX-ED02T/EM02T

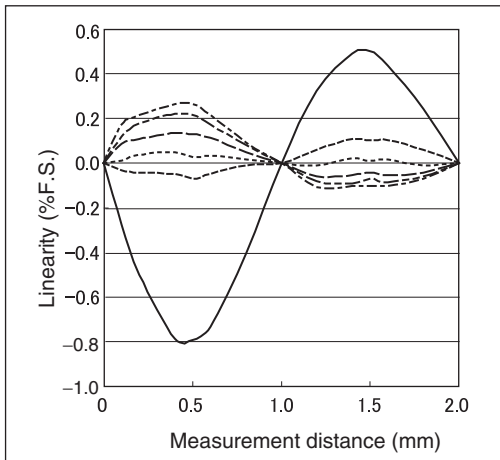

- S50C 5 × 5
- - - S50C 8 × 8
- · · S50C 12 × 12
- · - S50C 18 × 18
- - - S50C 30 × 30
- - - S50C 45 × 45

ZX-EM07MT

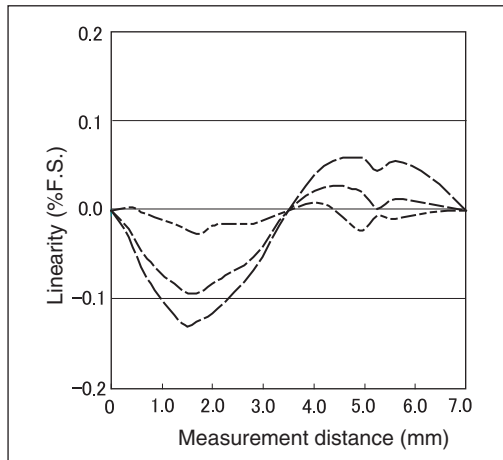

- - - S50C 30 × 30
- - - S50C 45 × 45
- S50C 60 × 60

ZX-EV04T

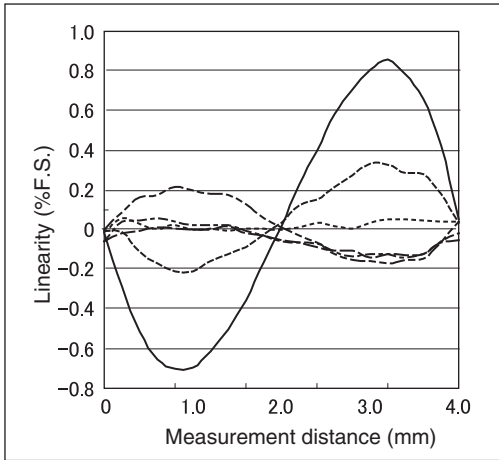

- S50C 8 × 8
- - - S50C 12 × 12
- · · S50C 18 × 18
- · - S50C 30 × 30
- - - S50C 45 × 45
- · - S50C 60 × 60

ZX-EM02HT

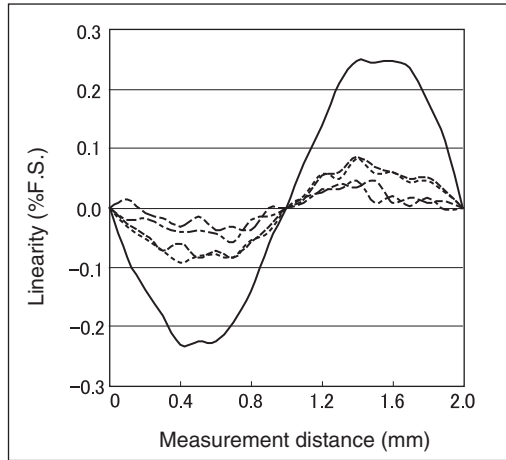

- S50C 8 × 8
- - - S50C 12 × 12
- · · S50C 18 × 18
- · - S50C 30 × 30
- - - S50C 45 × 45

Measuring Sensing Objects of Different Materials (Iron, Stainless Steel, and Aluminum) after Iron Selected as Material and Linearity Adjusted

 p. 54

ZX-EDR5T

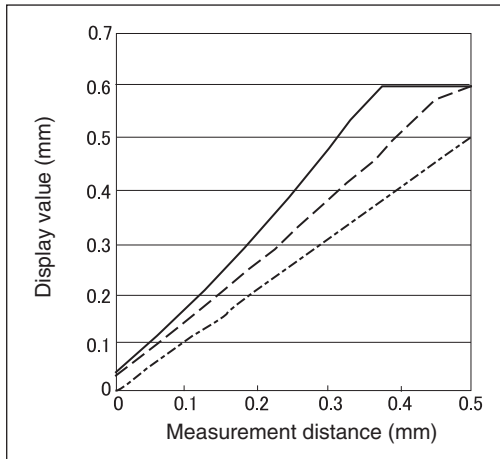

----- S50C 18 × 18
 ---- SUS304 18 × 18
 ——— A5052 18 × 18

ZX-ED01T

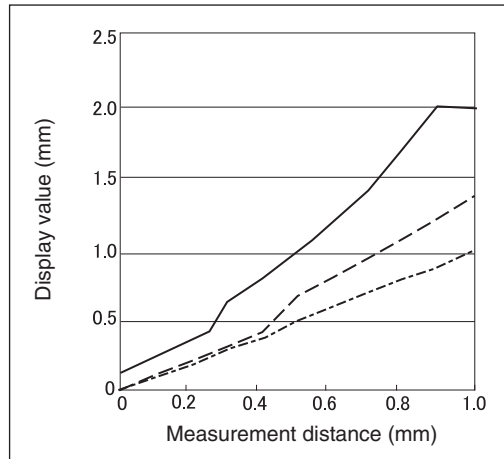

----- S50C 18 × 18
 ---- SUS304 18 × 18
 ——— A5052 18 × 18

ZX-ED02T/EM02T

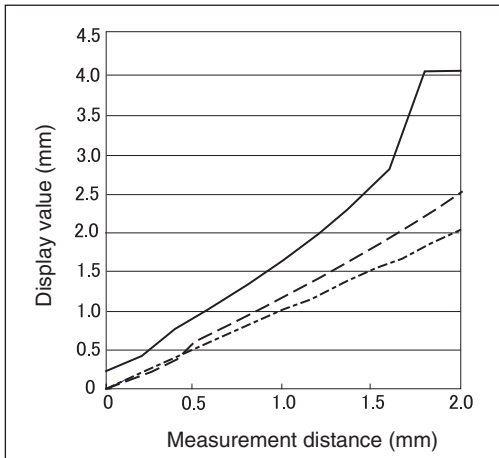

----- S50C 30 × 30
 ---- SUS304 30 × 30
 ——— A5052 30 × 30

ZX-EM07MT

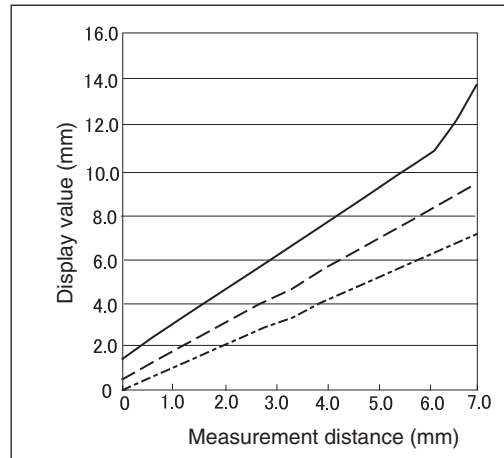

----- S50C 60 × 60
 ---- SUS304 60 × 60
 ——— A5052 60 × 60

ZX-EV04T

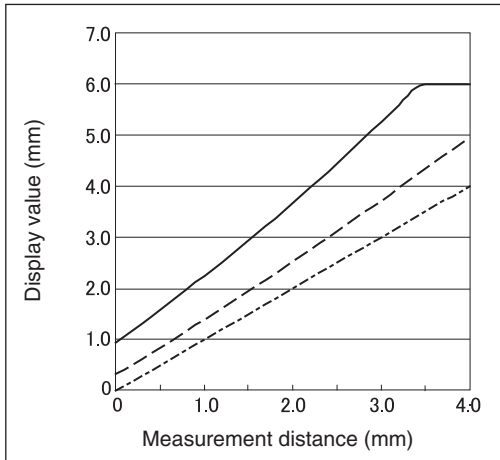

-----	S50C	60 × 60
-----	SUS304	60 × 60
-----	A5052	60 × 60

Selecting Material for Each Sensing Object (Iron, Stainless Steel, or Aluminum) and then Adjusting Linearity

(The measured sensing object is the same as the object for which linearity was adjusted.)



p. 54

ZX-EDR5T

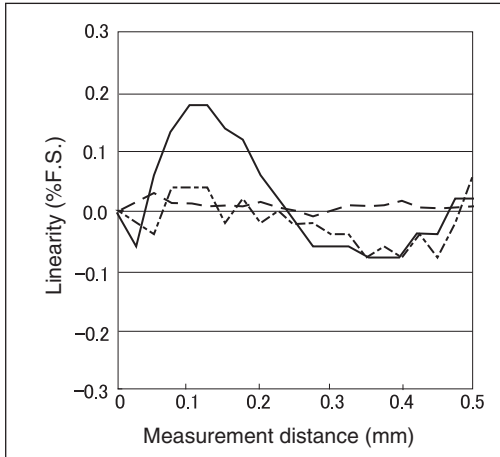

-----	S50C	18 × 18
-----	SUS304	18 × 18
-----	A5052	18 × 18

ZX-ED01T

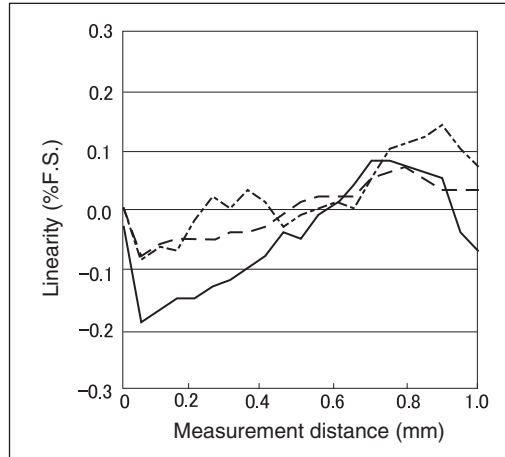

-----	S50C	18 × 18
-----	SUS304	18 × 18
-----	A5052	18 × 18

ZX-ED02T/EM02T

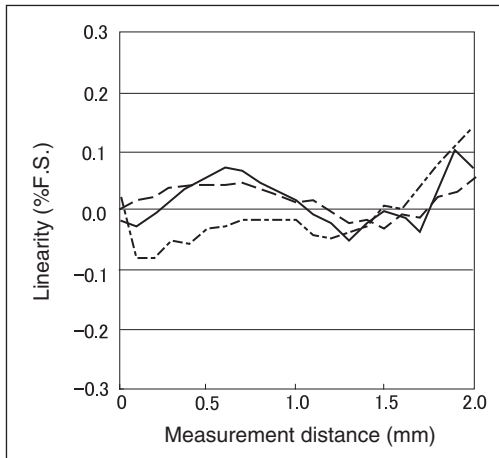

-----	S50C	30 × 30
-----	SUS304	30 × 30
-----	A5052	30 × 30

ZX-EM07MT

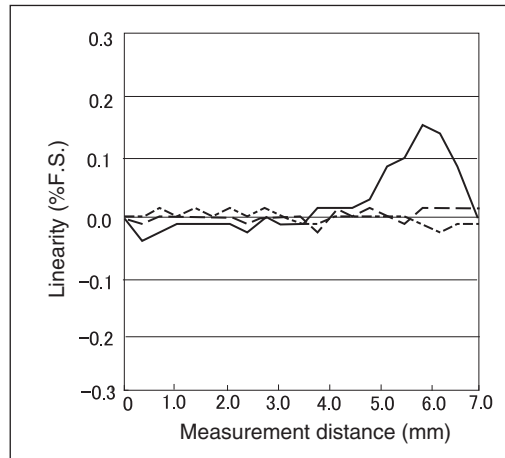

-----	S50C	60 × 60
-----	SUS304	60 × 60
-----	A5052	60 × 60

ZX-EV04T

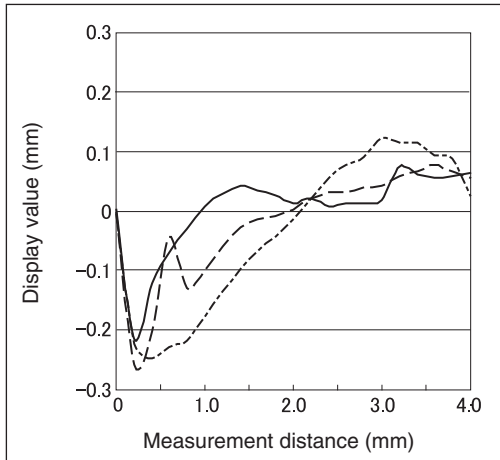

---	S50C	60 × 60
- - -	SUS304	60 × 60
—	A5052	60 × 60

Quick Reference for Displays

Using the Quick Reference

Items in the *Display* column marked with an asterisk (*) appear on the sub-display. All other items appear on the main display.

	Display		Details	Pages
1	1-Sht (*)	1-SHT	Timer/One-shot timer	p. 112
A	A20mA	A20mA	The meaning of this display item depends on the selected functions. Monitor focus/First point setting (for current output) Linear output correction/First point offset (for current output)	p. 103 p. 107
	A 4V	A 4V	The meaning of this display item depends on the selected functions. Monitor focus/First point setting (for voltage output) Linear output correction/First point offset (for voltage output)	p. 103 p. 107
	A-b (*)	A-B	2-sensor operation/A-B	p. 116
	A Ib (*)	AIB	2-sensor operation/A+B	p. 116
	AL (*)	AL	Linearity adjustment/Sensing object material/Aluminum, copper	p. 54
	ALL (*)	ALL	Displays all of the special menu.	p. 51
	AUTot (*)	AUTOT	T mode/Executing automatic teaching	p. 100
	AVE	AVE	Number of samples to average setting	p. 80
	AVE-h (*)	AVE-H	Hold/Average hold	p. 81
B	B 4mA	B 4mA	The meaning of this display item depends on the selected functions. Monitor focus/Second point setting (for current output) Linear output correction/Second point offset (for current output)	p. 103 p. 107
	B 4V	B 4V	The meaning of this display item depends on the selected functions. Monitor focus/Second point setting (for voltage output) Linear output correction/Second point offset (for voltage output)	p. 103 p. 107
	B-h (*)	B-H	Hold/Bottom hold	p. 81
C	calc	CALC	Calculation setting for adjacent Sensors	p. 116
	CLAMP	CLAMP	Clamp value setting for non-measurement	p. 110
	CLAMP (*)	CLAMP	Non-measurement setting/Return output to clamp value	p. 110
	close (*)	CLOSE	Hides the special menu.	p. 51
	comp	COMP	Compares to previous hold value.	p. 88

Display		Details		Pages
D	d000	D000	Linearity adjustment value input at 0% of measurement distance position	p. 56
	d050	D050	Linearity adjustment value input at 50% of measurement distance position	p. 56
	d100	D100	Linearity adjustment value input at 100% of measurement distance position	p. 56
	d-FYd (*)	D-FWD	Display direction for measured values when scaling function used (display not inverted)	p. 90
	d-Inv (*)	D-INV	Display direction for measured values when scaling function used (display inverted)	p. 90
	dIGit	DIGIT	Number of digits setting for main and sub-displays	p. 123
	doYn (*)	DOWN	Hold/Trigger mode/Self-down trigger	p. 83
	drEv	DREV	Reverses position of main and sub-displays.	p. 124
	dISP (*)	DISP	Displays display-related functions from special menu.	p. 51
E	EcO	ECO	Reduces power consumption by reducing main and sub-display lighting.	p. 126
	EtC (*)	ETC	Displays functions other than display- and output-related functions from special menu.	p. 51
F	FE (*)	FE	Linearity adjustment/Sensing object material/Iron, Stainless steel (SUS410)	p. 54
	FocUS	FOCUS	Measured value output range setting	p. 103
H	h-dLY	H-DLY	Hold/Delay hold	p. 86
	h-d-t	H-D-T	Hold/Delay hold/Delay time setting	p. 86
	h-hYS	H-HYS	Hold/Trigger mode/Self-trigger hysteresis width setting	p. 83
	h-LvL	H-LVL	Hold/Trigger mode/Self-trigger level setting	p. 83
	h-S-t	H-S-T	Hold/Delay hold/Sampling period setting	p. 86
	h-trG	H-TRG	Hold/Trigger mode setting	p. 83
	hold	HOLD	Hold setting	p. 81
	hYS	HYS	Hysteresis width setting	p. 102
I	inIt	INIT	Initialization of settings	p. 135
K	KEEP (*)	KEEP	Non-measurement settings/Hold output	p. 110
L	L-Adj	L-ADJ	Linear output offset value setting	p. 107
	LinEr	LINER	Linearity adjustment	p. 54
	LinIt	LINIT	Initialization of linearity adjustment data	p. 59
M	MAx (*)	MAX	Non-measurement settings/Clamp value/Maximum	p. 110
	MEtAL	METAL	Linearity adjustment/Sensing object material	p. 54
O	off-d (*)	OFF-D	Timer/Off-delay	p. 112
	on-d (*)	ON-D	Timer/On-delay	p. 112

Display		Details		Pages
P	P1SCL (*)	P1SCL	Scaling/First-point scaling	p. 90
	P2SCL (*)	P2SCL	Scaling/Second-point scaling	p. 90
	P-h (*)	P-H	Hold/Peak hold	p. 81
	PP-h (*)	PP-H	Hold/Peak-to-peak hold	p. 81
R	rESEt	RESET	Output data settings for non-measurement	p. 110
	rESEt (*)	RESET	RUN or T mode/Resetting input	p. 38
S	S-ch	S-CH	Mutual interference prevention/No. of Units	p. 120
	S-h (*)	S-H	Hold/Sample hold	p. 81
	ScALe	SCALE	Scaling setting	p. 90
	SEt (*)	SET	The meaning of this display item depends on the main display. SPcL : Displays output-related functions from special menu LInEr : Linearity adjustment	p. 51 p. 54
	SPcL	SPCL	Special menu Displays scaling, monitor focus, and other special functions.	p. 51
	SUS (*)	SUS	Linearity adjustment/Sensing object material/Stainless steel (SUS340)	p. 54
	SYnc	SYNC	Mutual interference prevention setting	p. 120
T	t-tiM	T-TIM	Timer time	p. 112
	tAbLE	TABLE	The meaning of this display item depends on the sub- display. StArt : Executing linearity adjustment cAncl : Canceling linearity adjustment	p. 58
	thiCk	THICK	2-sensor operation/Thickness setting	p. 116
	tImEr	TIMER	Judgement output timing setting	p. 112
	tImIG (*)	TIMIG	The meaning of this display item depends on the selected mode. FUN mode: Hold/Trigger mode/Timing input RUN or T modes: Input timing	p. 83 p. 38
U	UP (*)	UP	Hold/Trigger mode/Self-up trigger	p. 83
W	w-UP	W-UP	Displayed during warm-up	p. 41
Z	ZrDSP	ZRDSP	Offset value input for zero reset	p. 127
	ZrMEm	ZRMEM	Setting to save or clear measured values at zero reset	p. 130

Index

Numerics

1-point scaling	92
1-shot timer	112
2-point scaling	95

A

alphabet display format	47
Amplifier Units	
dimensions	140
installation	28
measuring with multiple Units	116
part names	25
specifications	140

B

basic configuration	24
---------------------------	----

C

cable length	20
Calculating Units	
connections	35
dimensions and specifications	145
part names	26
calculations	116
adding and subtracting	117
No. of connectable Units	35
sum or difference	73
thickness	118
channel numbers	36
characteristic data	148
circuit diagrams	
NPN Amplifier Units	39
PNP Amplifier Units	40
CLAMP	110
CLAMP value	110
comparison, previous values	88
current/voltage switch	25
cursor keys	48

D

deadpoint	
detecting	62
default values	
settings data	133
delays	
hold	86
setting time	86
dimensions	140
direct input	98
displays	

adjusting brightness	126
changing No. of digits	123
reversing	124

E

eccentricity	
measuring	71
ECO display	126
ENABLE indicator	25
error messages	137

F

FUN mode	
description	46
displays	47
function transitions	52
function transition charts	51

G

ground line	38
-------------------	----

H

height	
measuring	67
HIGH judgement output line	38
hold	
average	82
bottom	81
functions	81
mode	81
peak	81
peak-to-peak	82
sample	82
setting conditions	81
hysteresis width	83, 102

I

I/O circuit diagrams	39
initialize	
settings data	133
initializing	
linearity	59
Interface Units	
connections	37
connector pin arrangement	146
dimensions and specifications	146
part names	27

J

- judgement output hold input line 38
- judgement output timing..... 112

K

- KEEP 110
- key input
 - disabling..... 132
- key lock
 - releasing 132
 - setting 132
- key operations..... 48

L

- linear output 103
- output compensation 107
- switch..... 25
- linear output ground line 38
- linear output line..... 38
- linearity
 - adjusting 58
 - initializing adjustment settings 59
- LOW judgement output line 38

M

- main display 47
- materials
 - selecting..... 54
- measured value 139
- measurement distance..... 143
- mode switch 46
- modes 46
- switching..... 46
- mutual interference
 - preventing 19
 - setting distance..... 32

N

- No. of samples to average 80
- non-measurement settings 110
- numerals
 - changing 50

O

- OFF-delay timer 112
- ON-delay timer..... 112
- output cable 38
- output compensation..... 107
- output settings..... 103

P

- PASS judgement output line 38

- position teaching..... 99
- Power ON indicator 25
- Preamplifiers..... 33
- present value 139

Q

- Q&A 138

R

- reference values
 - displaying 127
 - setting offset values..... 128
- reset input line 38
- response time 116, 120, 139
- RUN mode
 - description 46
 - displays 47
 - function transitions 51

S

- scale
 - changing..... 90
- Sensor Heads..... 30
- connections 34
- dimensions 142
- influence of surrounding metal 31
- installation 30
- mutual interference..... 32
- part names 26
- preventing mutual interference..... 120
- specifications..... 143
- setting conditions
 - selecting 49
- setting distance..... 32
- settings
 - initializing..... 133
- specifications 140
- sub-display 47

T

- T mode
 - description 46
 - displays 47
 - function transitions 51
- teaching 97
- automatic 100
- terminology 139
- thickness
 - measuring..... 74
- thresholds
 - automatic teaching 100
 - entering values 97
 - inputting directly 98
 - position teaching 99

switch.....	25
timers	112
timing	
input.....	83
input line	38
trigger	
self-up	83
trigger mode	
selecting.....	83
troubleshooting	136

V

vibration	
measuring	71

W

warming up	12, 17, 41, 159
wiring.....	38

Z

zero reset	127
executing	129
input line	38
releasing	130
saving	130
setting offset values.....	128

Revision History

A manual revision code appears as a suffix to the catalog number at the bottom of the front and back covers of this manual.

Cat. No. Z166-E1-02A



Revision code

Revision code	Date	Revised contents
01	Sept. 2002	Original production
02	Sept. 2003	Added information on new Sensor models and details of version upgrade.
02A	April 2005	Pages 7 to 10: Updated warranty and limitations of liability information. Page 54: Corrected "SUS340" to "SUS304" in table.

